



**YOU'LL FLINCH
LONG BEFORE
THEY DO.**

MINIMIZER POLY PRODUCTS

• TESTED AND TORTURED™ •

DAILY BY TRUCKERS FOR TRUCKERS



AN AMERICAN FAMILY OWNED COMPANY FOR 30 YEARS

MINIMIZER.COM

800.248.3855



AN AMERICAN FAMILY OWNED COMPANY FOR 30 YEARS



Dear Friends of Minimizer™,

Welcome to our New 2014 CATALOG and thank you for your interest in Minimizer™; home of heavy-duty truck fenders, bracket kits, tool boxes, floor mats, mud flaps and accessories. It gives me great pride this year to celebrate MINIMIZER'S 30TH ANNIVERSARY. For 30 years we've been an American family owned company, manufacturing in the heartland of the Good Ole' USA, and delivering the industry's toughest products, guaranteed for life.

Without you, it wouldn't be possible. We thank you for your business and your continued COMMITMENT TO THE TRUCKING INDUSTRY.

In our new catalog you can see that THE WORLD OF MINIMIZER™ continues to grow. As a result of customer feedback from people like you we're constantly improving our product lines. Check out the NEW CUSTOM FLOOR MAT options, our NEW PADDLE BRACKETS for that seamless look and the NEW DECORATED BRACKETS so you can get it your way. Our new line of CHROME POLY and CARBON FIBER FENDERS continues to transform the industry. New for 2014, clean up the look of your old tire rims and wheels with our exciting NEW TIRE MASK PRODUCT LINE!

Visit our INFORMATIVE WEBSITE AT WWW.MINIMIZER.COM and check out our new products and videos. Our NEW PROVING GROUNDS VIDEO proves the toughness of the Minimizer™ brand. We've got NEW FREQUENTLY ASKED QUESTIONS & INSTALLATION VIDEOS to make it easier for you to use our products. And, take a look at our new videos proving the HIGH-PERFORMANCE SPRAY SUPPRESSION FEATURES of Minimizer™ fenders, the quality and functionality of our NEW CUSTOMIZED FLOOR MATS and a highly entertaining video about the SUPERIORITY OF MINIMIZER™ FENDERS.

We love getting pictures of our products on your heavy-duty rigs! Send us a picture of your rig outfitted with Minimizer™ fenders and I'll send you a FREE CANVAS PRINT (see page 107 for more details)! Check out our SOCIAL MEDIA, it's updated every day with fresh content, informative videos, and the latest submissions from cool truckers like you all over the world.

It's been 30 years and you can still count on the MINIMIZER™ ADVANTAGE, built USA tough: This INDUSTRY LEADING ADVANTAGE means our fenders never need paint, the color never fades, they never rust or crack and they never need polishing. We now offer UNIQUE OPTIONS to make your rig stand out from the crowd including CARBON FIBER, CHROME POLY, DIAMOND PLATE, LIQUID PLATIUM AND PAINTABLE fender finishes. Our fenders work in tandem with our INDUSTRY-LEADING BRACKET SYSTEMS to reduce road vibration and absorb impact.

Best of all, the MINIMIZER™ ADVANTAGE means OUR FENDERS ARE GUARANTEED FOR LIFE! Our warranties are the best in the industry: Lifetime, 100%, written guarantee. And our world-class parts and service response teams are virtually real-time. We are here to work for you and deliver the products you need.

At Minimizer™, WE ARE COMMITTED TO THE TRUCKING COMMUNITY. From the days of my father inventing the Minimizer™ fender as an alternative to "old-school" metal and fiberglass fenders to our new next-generation poly products we continue to improve every day.

Thanks for your business. Enjoy the catalog!

Craig Kruckeberg
CEO & Chief Visionary
craig@minimizer.com



About Minimizer

Headquartered in Blooming Prairie, Minnesota, USA, Minimizer™ manufactures the lightest, most durable, longest lasting truck fenders, toolboxes, custom floor mats, custom mud flaps, industry-leading bracket kits, and truck accessories in the trucking industry. Family owned and operated for 30 years and three generations, Minimizer™ uses durable materials and proprietary processes to build long lasting products that are tough enough to please people in a tough industry.

AN AMERICAN FAMILY OWNED COMPANY FOR 30 YEARS

MINIMIZER.COM

800.248.3855

MINIMIZER INDEX

THE MINIMIZER ADVANTAGE

Minimizer Advantage
Bracket Systems
Unique Options

3-16

3 - 4
5 - 8
9 - 16



FENDERS

Single Axles
Tandem Axles
Multiple Axles
Half Fenders
Construction And Utility
Lift Axles And Steerable
Tanker Fenders
Quarter Fenders
Fender Options
Installation Kits

17-80

19 - 28
29 - 38
39 - 54
55 - 62
63 - 68
69 - 72
73 - 74
75 - 76
77 - 78
79 - 80



TOOL BOXES

Poly-Tool Boxes

81-84

83 - 84



ACCESSORIES

Floor Mats
Tire Mask
LED Lights
Lift Axle Brackets
Steerable Axle Brackets
Slick Disk
Mud Flaps

85-96

87 - 88
89 - 90
91
92
93
94
95 - 96



OTHER INFORMATION

Service Parts
Our Family's Warranty
Lawyer's Warranty
Maintenance
Return Policy
Minimizer On The Web
Customer Photos

97-110

99 - 100
101 - 102
103 - 104
105
106
107 - 108
109 - 110



THE MINIMIZER **ADVANTAGE** EXTREME

Minimizer™ fenders are manufactured using long chain hydrocarbon polyethylene material and thermoformed using proprietary technology. Minimizer™ fenders completely cover wheels and are designed with a unique lip



that provides superior control of spray and debris so your loads and equipment are safer and cleaner. When dented or crushed they bounce back into shape. The material is extremely durable, impervious to salt and corrosion, and can withstand temperatures ranging from -100° F to 197° F.

The award-winning Minimizer™ never stops innovating. We now go head-to-head with shiny metal fenders (that bend and break) with the introduction of the new Minimizer™ Chrome Poly. You get the remarkable shine and reflection of a metal fender combined with the

durability of The Minimizer™ Advantage. And now we've launched the new Minimizer™ Carbon Fiber Poly! This new look adds a unique style to any truck and trailer.

You want tougher products for your rig. You know Minimizer™ has always made the industry's most durable fenders. Now we're bringing you that same quality and dependability with the NEW Minimizer™ Floor Mats. You get the same product performance and guarantees you've come to expect from Minimizer™, custom-made to fit your rig!

SAFETY

In the past, when purchasing a truck, fenders were not a significant consideration. It was a bonus if fenders were included with the truck. But stock fenders didn't perform well and it didn't take long before they were destroyed.

Today, truckers and fleet owners are more conscientious about safety, spray and debris control, and aesthetics. They recognize safety, performance, and proper equipment maintenance have a direct connection with the bottom line. In many jurisdictions, the use of fenders is a legal requirement.

Let's talk about weight. Our moniker boasts we manufacture the lightest truck fenders. What does that mean to you? A lighter fender means better gas mileage, performance and efficiency. You want to be carrying loads not heavy fenders. Talk about a return on investment.

The right product must be chosen. Nothing beats Minimizer™!

SEE IT

You have to see the performance of Minimizer™ fenders to believe it. Check out the video section at www.minimizer.com to see the abuse our fenders can take in the new Proving Grounds video and watch the new Anti-Spray video that shows our fenders ability to control debris and overspray!



AN AMERICAN FAMILY OWNED COMPANY FOR 30 YEARS

MINIMIZER.COM

800.248.3855

PERFORMANCE

STANDARD FENDERS

Minimizer™ offers a variety of semi-truck fender styles, colors and options. With an outstanding reputation of quality, durability, and style, our fenders will enhance your truck's appearance and lifespan. Minimizer™ truck fenders never rust because they are a proprietary Minimizer™ material. The color is molded throughout so chips, scuffs and scratches can't be seen. The fender never needs to be painted and never fades. The Minimizer™ fender itself should never need maintenance other than the occasional wash using any all-purpose cleaner. Contact us for more information on semi-truck and trailer fenders.

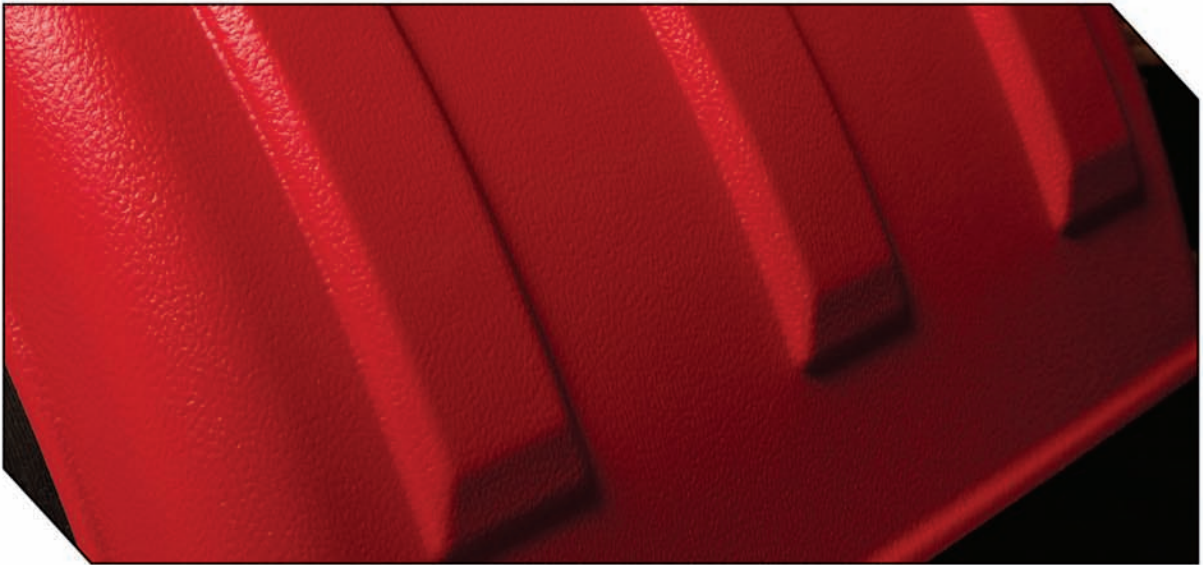

NEVER NEEDS PAINT: Color is molded throughout, so chips, scuffs and scratches can't be seen.

NEVER FADES: UV inhibitors are built into the material.

NEVER RUSTS: Material is 100% polyethylene.

NEVER STRESS CRACKS: The unique material is not affected by road conditions.

NEVER NEEDS POLISHING: Simply clean with soap and water.

Black



Galvanized



Red



White



Green



BRACKET **SYSTEMS**

MINIMIZER™ OFFERS THE BEST FENDER BRACKET SYSTEMS IN THE INDUSTRY.
HERE'S **WHY**: ULTIMATE **DURABILITY**



- Won't stay bent • Made from 100% composite material
- Won't stress crack • Never needs paint • Softens road vibration

MINIMIZER™ BRACKETS AND FENDERS WORK TOGETHER
TO ABSORB IMPACT.
IF THEY BEND, THEY SPRING BACK!

AN AMERICAN FAMILY OWNED COMPANY FOR 30 YEARS

MINIMIZER.COM

800.248.3855

MINIMIZER ADVANTAGE

The competition gives you metal brackets with composite fenders.
WHY? We do it right, you get an indestructible bracket with your Minimizer™ fender!



You've got to have the right tools for the trade, right? You know that already, you bought Minimizer™ fenders! What would indestructible fenders be without indestructible brackets to match?

You need brackets that won't bend out of shape with the slightest tap or break and do nothing but cost you hard earned money. At Minimizer™ our fenders AND brackets are guaranteed for life! That's good math for you! How can Minimizer™ make such an offer? It's simple, we have total confidence in the design and performance of our fenders and bracket kits.

Minimizer™ brackets are designed for strength - they won't stress crack, never need painting and they soften road vibration. Minimizer™ brackets have remarkable staying power - when bumped or bent they "give" slightly and spring back into shape without dents or paint chips. These brackets will last as long as you own your Minimizer™ fenders - we guarantee it!

Use the best fender bracket system available. Offered exclusively from Minimizer™ distributors worldwide.

MINIMIZER™ POLY BRACKET SYSTEMS ARE
GUARANTEED FOR LIFE!
THE BEST FENDER BRACKET SYSTEM AVAILABLE.

OFFERED EXCLUSIVELY FROM MINIMIZER™ DISTRIBUTORS WORLDWIDE.

500 MINIMIZER WAY SE, BLOOMING PRAIRIE, MN 55917



BRACKET **SYSTEMS** THE MINIMIZER

INTRODUCING THE NEW PADDLE BRACKET ARM FROM MINIMIZER™!
SLEEK NEW **LOOK:** SAME **DURABILITY**



MINIMIZER BRACKETS AND FENDERS WORK TOGETHER
TO ABSORB IMPACT.
IF THEY BEND, THEY SPRING BACK!

AN AMERICAN FAMILY OWNED COMPANY FOR 30 YEARS

MINIMIZER.COM

800.248.3855

MINIMIZER ADVANTAGE

- EASIER INSTALLATION • REDUCES SUSPENSION BULK • SMOOTHER LOOK
- WON'T STAY BENT • MADE FROM 100% COMPOSITE MATERIAL
- WON'T STRESS CRACK • NEVER NEEDS PAINT • SOFTENS ROAD VIBRATION



The **NEW** Minimizer™ Paddle Bracket kits are designed for direct mounting to the frame eliminating the need to use spacers in most cases. The more compact profile allows the bracket arm to fit lower on the frame rail if needed, allowing more clearance between the frame and the fifth wheel plate. All of the fastening hardware is hidden beneath the fender creating a more streamlined and aesthetically pleasing look. But don't let it's good looks fool you, it has been tested and tortured to ensure that it will meet the demands of a tough industry and the daily abuse of the road.

CARBON FIBER

U



THE LATEST IN **INNOVATION**

The Latest in Innovation from Minimizer™, the distinctive look of Carbon Fiber... Combined with the unmatched advantages of Minimizer™ fenders: **NO PAINTING, NO FADING, NO RUST AND NO CRACKS.** Minimizer™ Carbon Fiber fenders are the first of our unique Paint Films to hit the market and are now available via the Minimizer™ World-Wide Distribution Network.

AN AMERICAN FAMILY OWNED COMPANY FOR 30 YEARS

MINIMIZER.COM

800.248.3855

NIQUE OPTIONS



Minimizer™ Fenders with a carbon fiber finish, unmatched by any fender on the market.

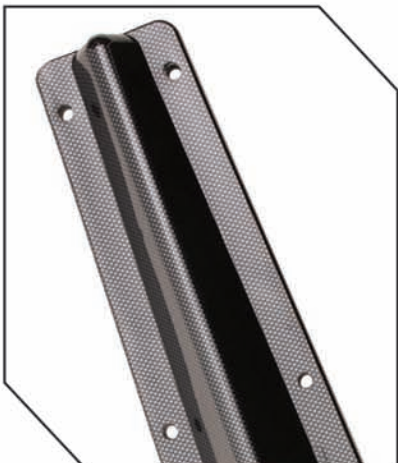

CARBON FIBER DECORATED BRACKETS

Now Minimizer™ offers multiple decorated bracket arm finishes. Each option provides the same high level of performance and durability as our standard black poly bracket arms. It's our latest innovation in unique aftermarket products.

CHROME POLY



AN INDUSTRY **BREAKTHROUGH**

The Industry's first and only Chrome Poly fender, With a remarkable shine and reflection that metal fenders can't match... Combined with the unmatched advantages of Minimizer™ Fenders: **NO PAINTING, NO FADING, NO RUST AND NO CRACKS.** Minimizer™ Chrome Poly fenders are now available via the Minimizer™ World-Wide Distribution Network.

AN AMERICAN FAMILY OWNED COMPANY FOR 30 YEARS

MINIMIZER.COM

800.248.3855

NIQUE OPTIONS



Minimizer™ Fenders with a mirror-like finish, unmatched by any fender on the market.

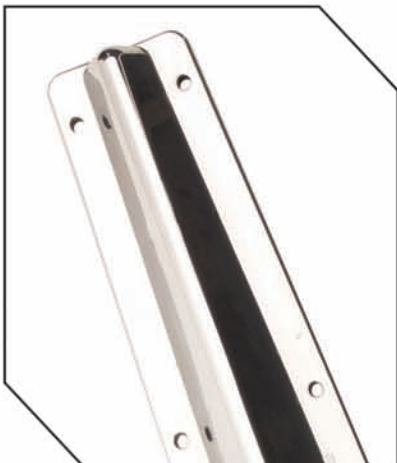

CHROME POLY DECORATED BRACKETS

Now Minimizer™ offers multiple decorated bracket arm finishes. Each option provides the same high level of performance and durability as our standard black poly bracket arms. It's our latest innovation in unique aftermarket products.

500 MINIMIZER WAY SE, BLOOMING PRAIRIE, MN 55917



LIQUID PLATIUM

U



AN INDUSTRY **BREAKTHROUGH**

Tired of fenders denting, cracking, or rusting, but crave the beautiful shine of metal fenders? Liquid Platium finished fenders are for you. These fenders are made from a TPO material that's laminated with the same Class A finish film widely used in the automotive industry. Fenders shine up with soap and water with NO buffing... ever. Liquid Platium is currently available in most fender models.

AN AMERICAN FAMILY OWNED COMPANY FOR 30 YEARS

MINIMIZER.COM

800.248.3855

NIQUE OPTIONS



Minimizer™ Fenders that look like shiny metal... but last like our incredible fenders.

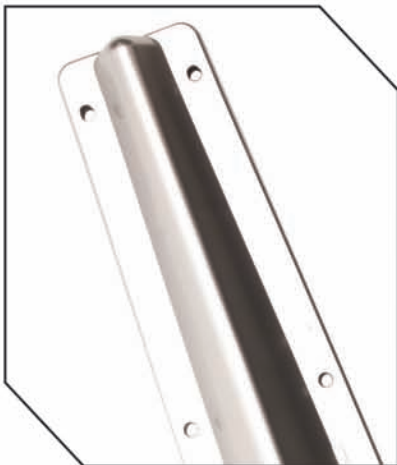

LIQUID PLATIUM DECORATED BRACKETS

Now Minimizer™ offers multiple decorated bracket arm finishes. Each option provides the same high level of performance and durability as our standard black poly bracket arms. It's our latest innovation in unique aftermarket products.

500 MINIMIZER WAY SE, BLOOMING PRAIRIE, MN 55917



PAINTABLE



Minimizer™ fenders now come in a paintable version. Your body shop specialist can paint them to match just about any color. The shine and finish rival fiberglass or metal... but our fender's legendary durability stands alone.

Step 1



MOLD

Step 2



PRIME

Step 3



PAINT

AN AMERICAN FAMILY OWNED COMPANY FOR 30 YEARS

MINIMIZER.COM

800.248.3855

NIQUE OPTIONS

DIAMOND **PLATE**



Minimizer™ fenders that look like diamond plate... but last like our incredible fenders. Tired of fenders denting, cracking or rusting, but like the look of diamond plate? Diamond plate poly is available for most of our fender styles... a timeless great look, but with the durability of “never-dent” poly. Diamond Plate fenders are available for most fender models.

Available in Silver and Black



**YOU'LL FLINCH
LONG BEFORE
THEY DO.**

MINIMIZER POLY PRODUCTS

• **TESTED AND TORTURED™** •
DAILY BY TRUCKERS FOR TRUCKERS



Minimizer

FENDERS

MIN 1600



THE ONE TON

Single Axle Set: Dual 16.5" Wheels

- MIN1600 is designed to fit a single axle tractor or trailer with 16.5" wheels.
- The set consists of 2 pieces (2 - PM1601 single fenders).
- The total weight of the MIN1600 fender kit is less than 11 pounds.
- See page 77 for complete list of fenders and additional color, material, and lightbox options.

AN AMERICAN FAMILY OWNED COMPANY FOR 30 YEARS

MINIMIZER.COM

800.248.3855

THE ONE TON

"Just wanted to send you a picture of my new truck. The install was simple - I love my fenders."

SINGLE AXLE FENDERS **SPECS**

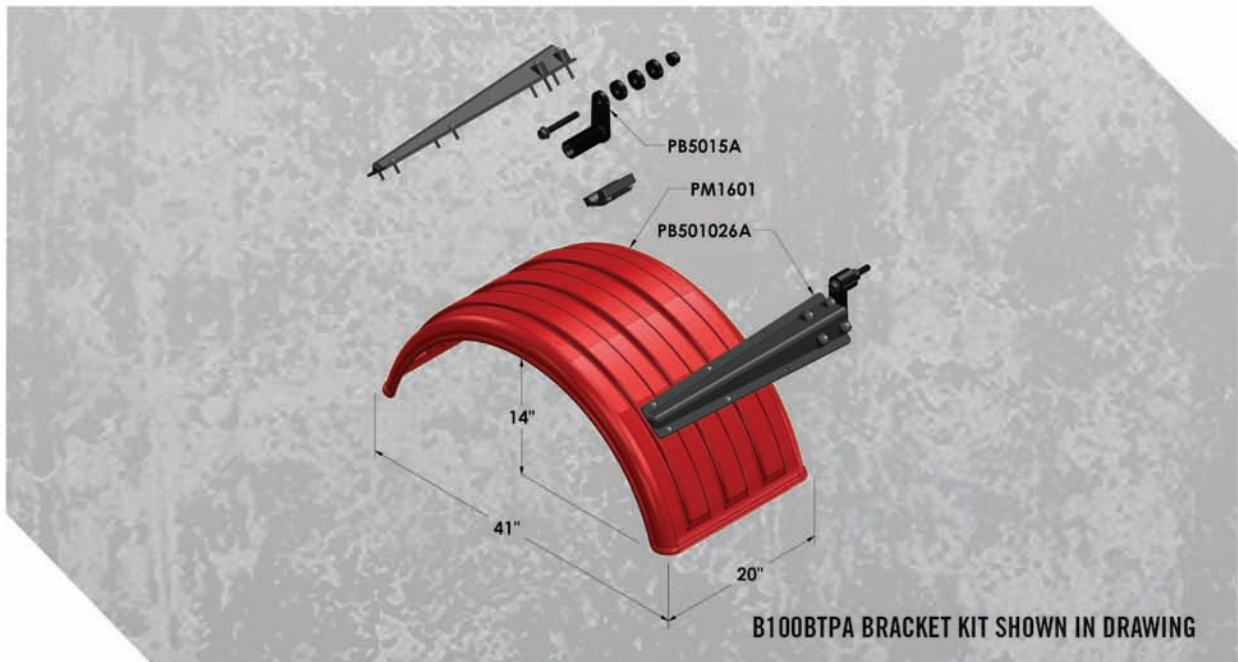

INSTALLATION **KITS**

- B100**BTPA** - Black Plastic Bolt-on Kit
- B100**BTPACF** - Carbon Fiber Plastic Bolt-on Kit
- B100**BTPACHROME** - Chrome Plastic Bolt-on Kit
- B100**BTPAPL** - Liquid Platinum Plastic Bolt-on Kit
- B100**PBA** - Plastic Paddle Bracket Bolt-on Kit
- B100**B TSA** - Stainless Bolt-on Kit
- B100**WOA** - Weld-on Kit

SEE **PAGE 79-80** FOR MORE INFORMATION ON AVAILABLE INSTALLATION KITS

MIN 1900



LIL' SCRAPPER

Single Axle Set: Dual 19.5" Wheels

- MIN1900 is designed to fit a single axle tractor or trailer with 19.5" wheels.
- The set consists of 2 pieces (2 - PM1901 single fenders).
- The total weight of the MIN1900 fender kit is less than 14 pounds.
- See page 77 for complete list of fenders and additional color, material, and lightbox options.

AN AMERICAN FAMILY OWNED COMPANY FOR 30 YEARS

MINIMIZER.COM

800.248.3855

LIL' SCRAPPER

"I love the way the fenders wrap around the tire for complete coverage."

SINGLE AXLE FENDERS **SPECS**

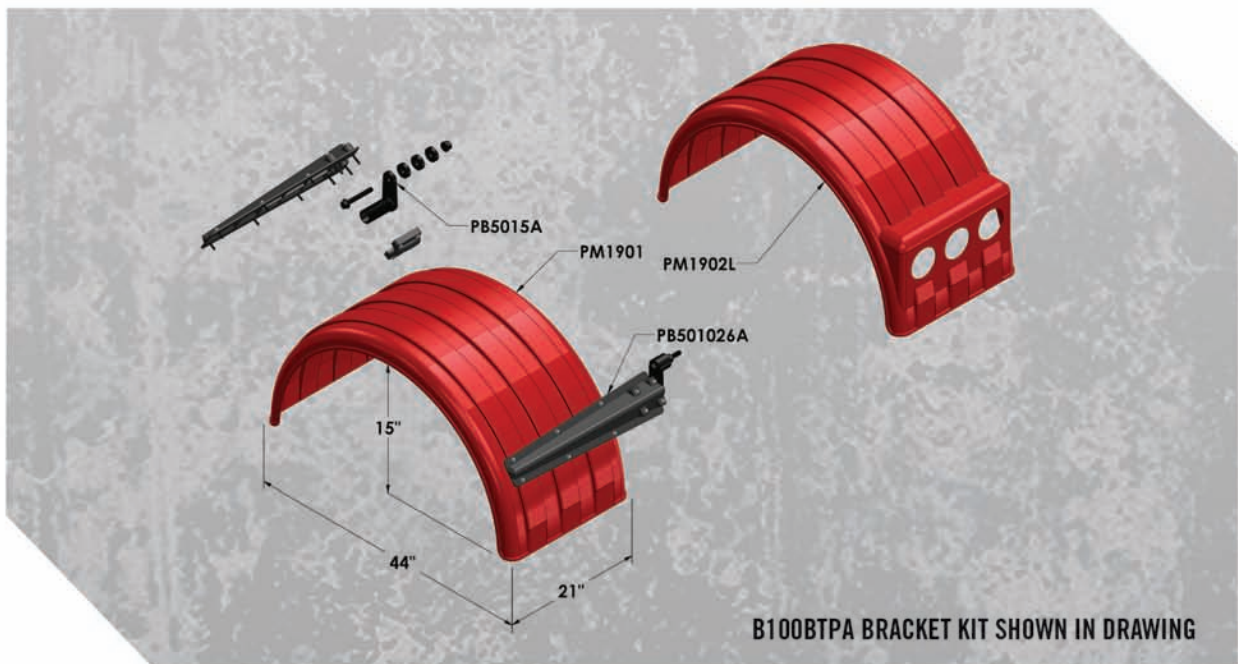

INSTALLATION **KITS**

- B100**BTPA** - Black Plastic Bolt-on Kit
- B100**BTPACF** - Carbon Fiber Plastic Bolt-on Kit
- B100**BTPACHROME** - Chrome Plastic Bolt-on Kit
- B100**BTPAPL** - Liquid Platinum Plastic Bolt-on Kit
- B100**PBA** - Plastic Paddle Bracket Bolt-on Kit
- B100**BTSA** - Stainless Bolt-on Kit
- B100**WOA** - Weld-on Kit

SEE **PAGE 79-80** FOR MORE INFORMATION ON AVAILABLE INSTALLATION KITS

MIN 2260



THE TT TWIN

Single Axle Set:

Dual 22.5" and 24.5" Wheels

- MIN2260 is designed to fit a single axle tractor or trailer with 22.5" or 24.5" wheels.
- The set consists of 2 pieces (2 - PM2261 single fenders).
- The total weight of the MIN2260 fender kit is less than 24 pounds.
- See page 77 for complete list of fenders and additional color, material, and lightbox options.

AN AMERICAN FAMILY OWNED COMPANY FOR 30 YEARS

MINIMIZER.COM

800.248.3855

THE TT TWIN

"I'm impressed with the 'showroom like' looks after thousands of miles on the road and years of abuse."

SINGLE AXLE FENDERS **SPECS**

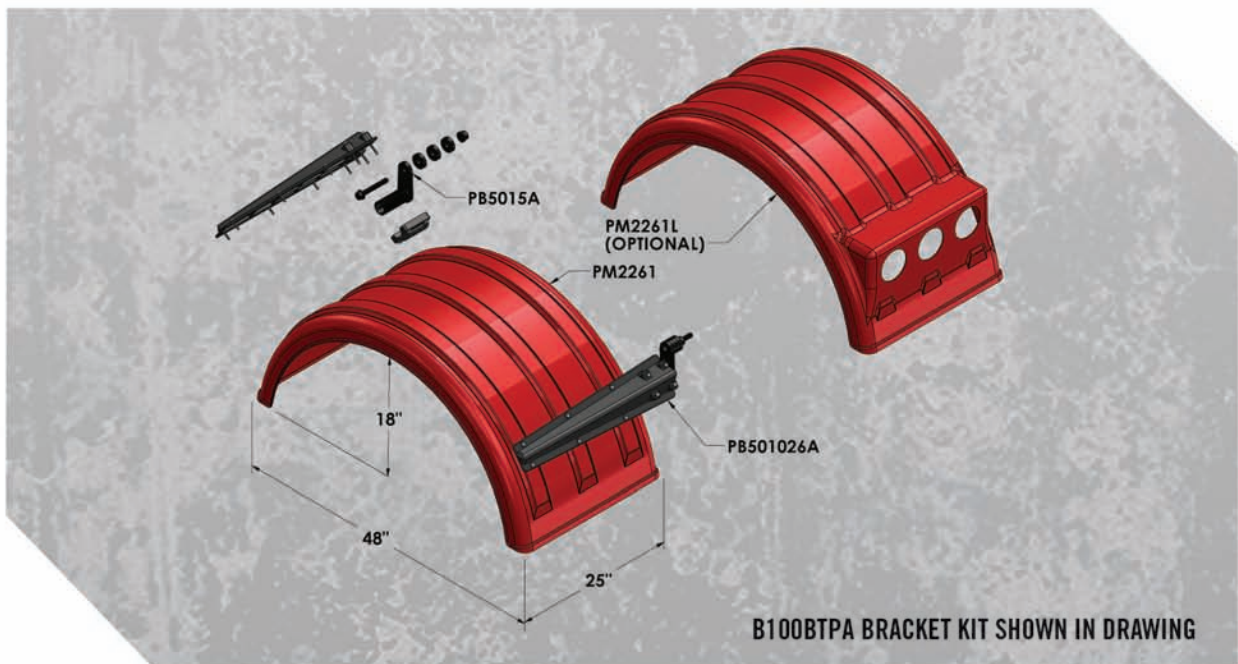

INSTALLATION **KITS**

- B100**BTPA** - Black Plastic Bolt-on Kit
- B100**BTPACF** - Carbon Fiber Plastic Bolt-on Kit
- B100**BTPACHROME** - Chrome Plastic Bolt-on Kit
- B100**BTPAPL** - Liquid Platinum Plastic Bolt-on Kit
- B100**PBA** - Plastic Paddle Bracket Bolt-on Kit
- B100**B TSA** - Stainless Bolt-on Kit
- B100**WOA** - Weld-on Kit

SEE **PAGE 79-80** FOR MORE INFORMATION ON AVAILABLE INSTALLATION KITS

MIN 2480

THE



THE TEXAS **DOUBLE**

**Single Axle Set:
Dual 24.5" Wheels**

- MIN2480 is designed to fit a single axle with 24.5" tractor or trailer wheels.
- The set consists of 2 pieces (2 - PM2481 single fenders).
- The total weight of the MIN2480 fender kit is less than 26 pounds.
- See page 77 for complete list of fenders and additional color, material, and lightbox options.

AN AMERICAN FAMILY OWNED COMPANY FOR 30 YEARS

MINIMIZER.COM

800.248.3855

TEXAS DOUBLE

"I love the way the fenders wrap around the tire for complete coverage."

SINGLE AXLE FENDERS **SPECS**

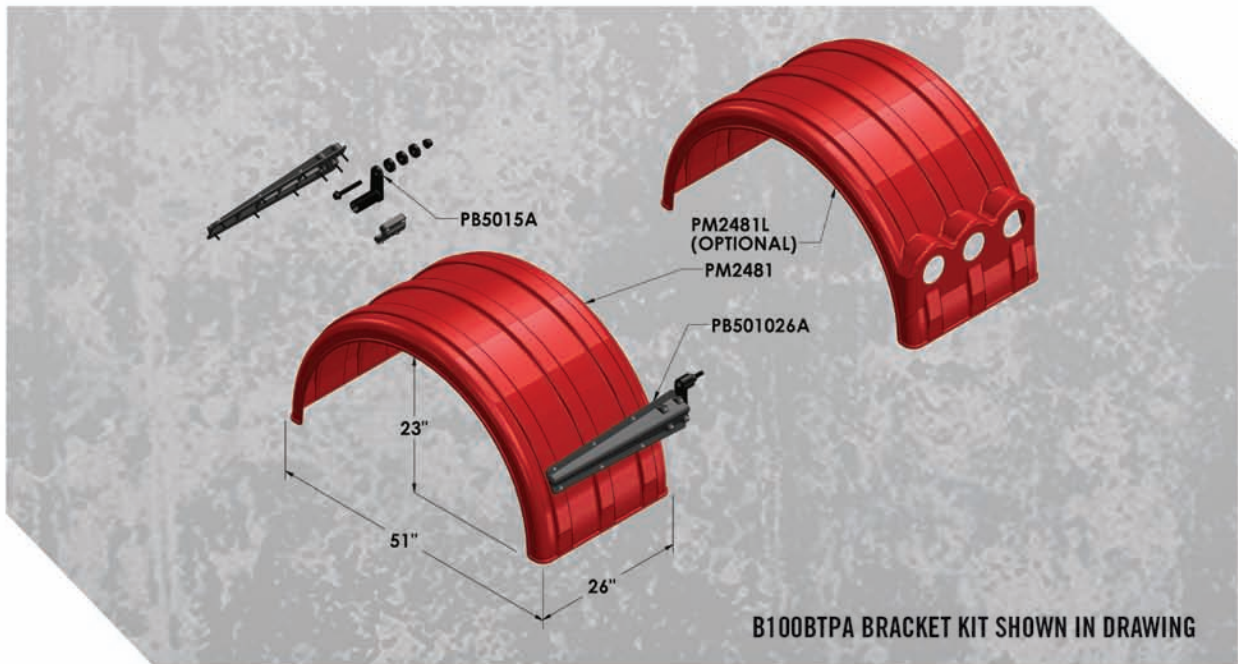

INSTALLATION **KITS**

- B100**BTPA** - Black Plastic Bolt-on Kit
- B100**BTPACF** - Carbon Fiber Plastic Bolt-on Kit
- B100**BTPACHROME** - Chrome Plastic Bolt-on Kit
- B100**BTPAPL** - Liquid Platinum Plastic Bolt-on Kit
- B100**PBA** - Plastic Paddle Bracket Bolt-on Kit
- B100**BTSA** - Stainless Bolt-on Kit
- B100**WOA** - Weld-on Kit

SEE **PAGE 79-80** FOR MORE INFORMATION ON AVAILABLE INSTALLATION KITS

MIN 150



**Single Axle Set:
Dual Wheels Up to 24.5"**

THE **EYEBROW**

- MIN150 is designed to fit 22.5" or 24.5" tractor or trailer wheels.
- The set consists of 2 pieces (2 - PM151 single fenders).
- The total weight of the MIN150 fender kit is less than 17 pounds.
- See page 77 for complete list of fenders and additional color, material, and lightbox options.

AN AMERICAN FAMILY OWNED COMPANY FOR 30 YEARS

MINIMIZER.COM

800.248.3855

THE EYEBROW

"My experiences with both the company and the product were terrific."

SINGLE AXLE FENDERS **SPECS**

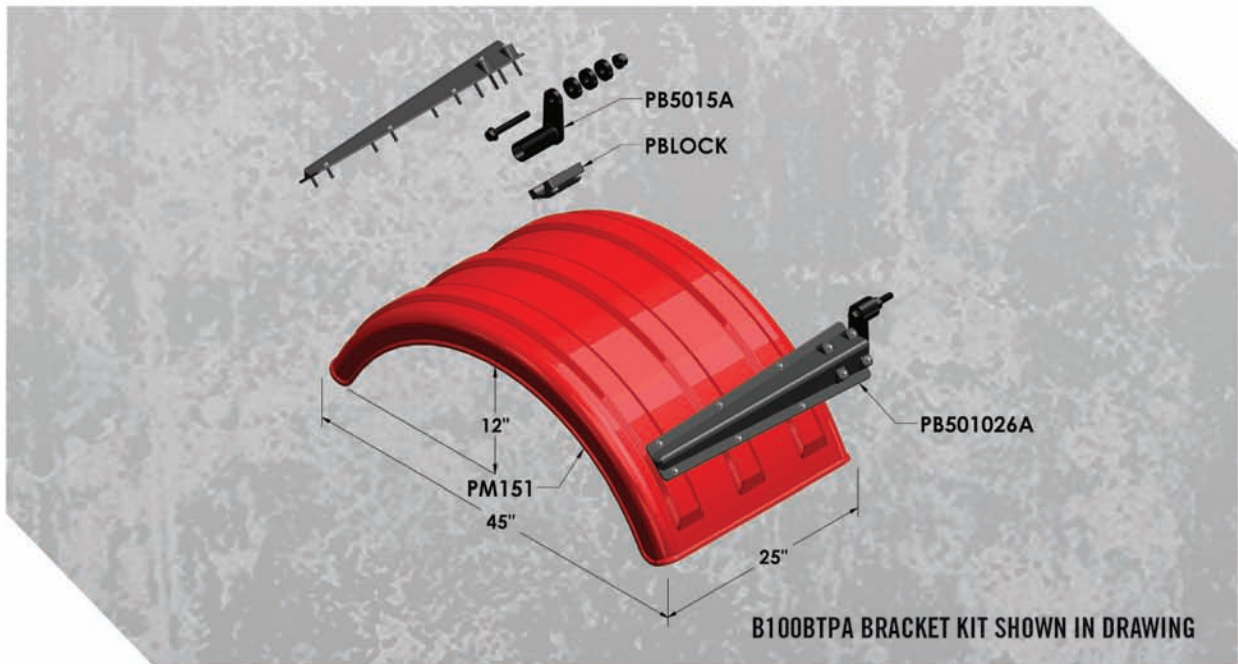

INSTALLATION **KITS**

- B100**BTPA** - Black Plastic Bolt-on Kit
- B100**BTPACF** - Carbon Fiber Plastic Bolt-on Kit
- B100**BTPACHROME** - Chrome Plastic Bolt-on Kit
- B100**BTPAPL** - Liquid Platinum Plastic Bolt-on Kit
- B100**PBA** - Plastic Paddle Bracket Bolt-on Kit
- B100**B TSA** - Stainless Bolt-on Kit
- B100**WOA** - Weld-on Kit

SEE **PAGE 79-80** FOR MORE INFORMATION ON AVAILABLE INSTALLATION KITS

MIN 200



Tandem Axle Set

THE ORIGINAL

- MIN200 is designed to fit a tandem axle tractor or trailer.
- The set consists of 4 pieces (4 - PM201 fender sections).
- The total weight of the MIN200 fender kit is less than 38 pounds.
- Optional trim plates are available.
- See page 77 for complete list of fenders and additional color, material, and lightbox options.

AN AMERICAN FAMILY OWNED COMPANY FOR 30 YEARS

MINIMIZER.COM

800.248.3855

THE ORIGINAL

"The best looking part of my truck is my fenders."

TANDEM AXLE FENDERS **SPECS**

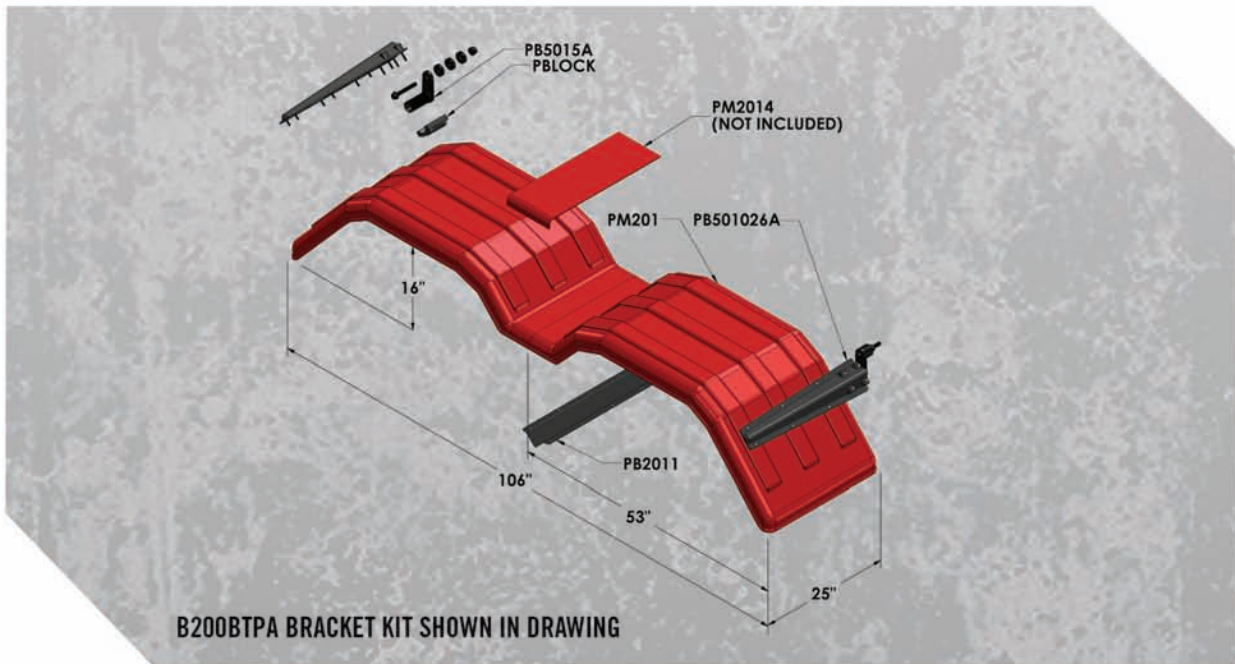

INSTALLATION **KITS**

- B200**BTPA** - Black Plastic Bolt-on Kit
- B200**BTPACF** - Carbon Fiber Plastic Bolt-on Kit
- B200**BTPACHROME** - Chrome Plastic Bolt-on Kit
- B200**BTPAPL** - Liquid Platinum Plastic Bolt-on Kit
- B200**PBA** - Plastic Paddle Bracket Bolt-on Kit
- B200**WOA** - Weld-on Kit

SEE **PAGE 79-80** FOR MORE INFORMATION ON AVAILABLE INSTALLATION KITS

MIN 4000

THE



Full Tandem Axle Set

THE WORK **HORSE**

- MIN4000 is designed to fit a tandem axle tractor or trailer.
- The set consists of 4 pieces (4-PM4001 fender sections).
- The total weight of the MIN4000 fender kit is less than 42 pounds.
- See page 77 for complete list of fenders and additional color, material, and lightbox options.

AN AMERICAN FAMILY OWNED COMPANY FOR 30 YEARS

MINIMIZER.COM

800.248.3855

WORK HORSE

“My line of work is demanding and hard on equipment but I never worry about my fenders..... Never.”

TANDEM AXLE FENDERS **SPECS**

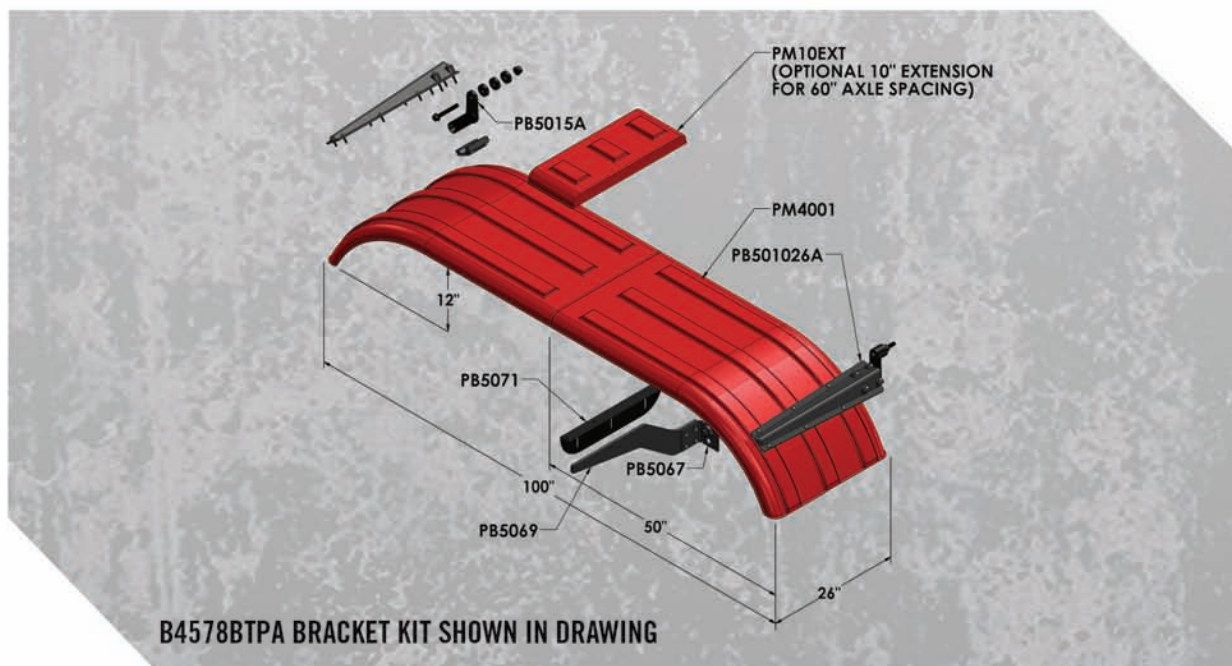

INSTALLATION **KITS**

- B4578**BTPA** - Black Plastic Bolt-on Kit
- B4578**BTPACF** - Carbon Fiber Plastic Bolt-on Kit
- B4578**BTPACHROME** - Chrome Plastic Bolt-on Kit
- B4578**BTPAPL** - Liquid Platinum Plastic Bolt-on Kit
- B4578**PBA** - Paddle Bracket Bolt-on Kit
- B4578**BTSA** - Stainless Bolt-on Kit
- B4578**WOA** - Weld-on Kit

SEE **PAGE 79-80** FOR MORE INFORMATION ON AVAILABLE INSTALLATION KITS

MIN 900



Full Tandem Axle Set

THE BRUTE

- MIN900 is designed to fit a tandem axle tractor or trailer.
- The set consists of 4 pieces (4 - PM901 single fenders).
- The total weight of the MIN900 fender kit is less than 52 pounds.
- See page 77 for complete list of fenders and additional color, material, and lightbox options.

AN AMERICAN FAMILY OWNED COMPANY FOR 30 YEARS

MINIMIZER.COM

800.248.3855

THE BRUTE

"I love the way the fenders wrap around the tire for complete coverage."

TANDEM AXLE FENDERS **SPECS**

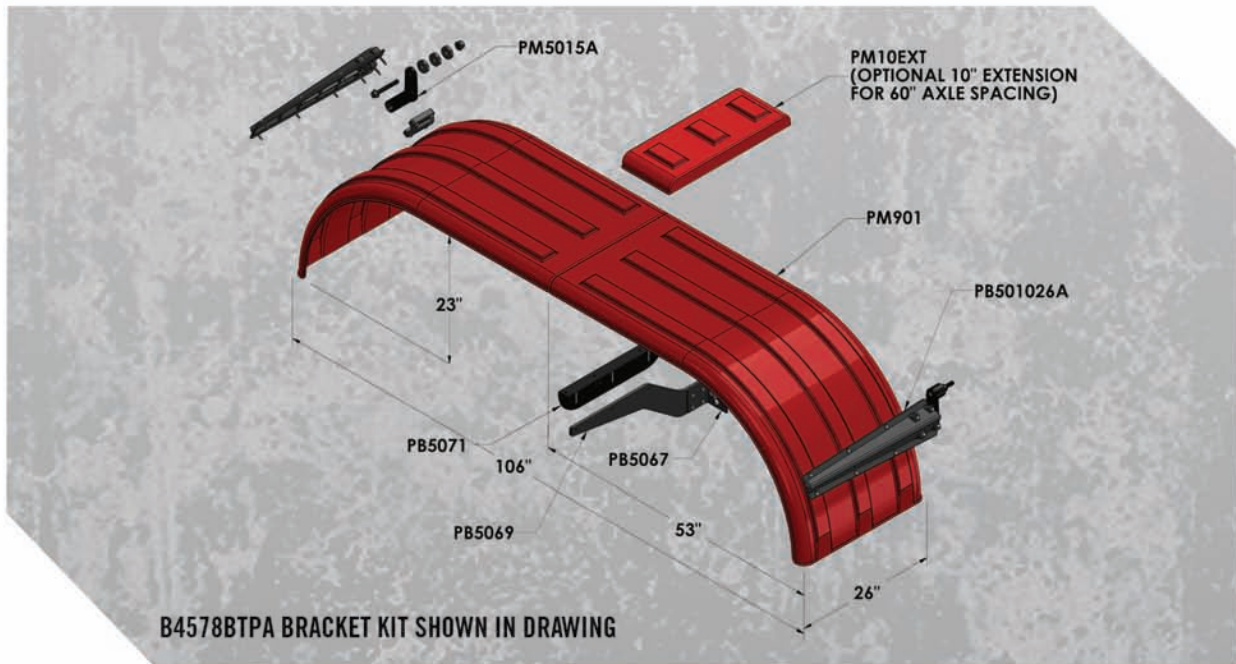

INSTALLATION **KITS**

- B4578**BTPA** - Black Plastic Bolt-on Kit
- B4578**BTPACF** - Carbon Fiber Plastic Bolt-on Kit
- B4578**BTPACHROME** - Chrome Plastic Bolt-on Kit
- B4578**BTPAPL** - Liquid Platinum Plastic Bolt-on Kit
- B4578**PBA** - Stainless Bolt-on Kit
- B4578**BTSA** - Plastic Paddle Bracket Bolt-on Kit
- B4578**WOA** - Weld-on Kit

SEE **PAGE 79-80** FOR MORE INFORMATION ON AVAILABLE INSTALLATION KITS

MIN 1352/1354 THE



Full Tandem Axle Set

THE DOUBLE **DEUCE**

- MIN1352/1354 is designed to fit a tandem axle tractor or trailer with either a 52" or 54" axle spread.
- The set consists of 4 pieces (4 - PM1301 single fenders).
- The total weight of the MIN1352/1354 fender kit is less than 44 pounds.
- See page 77 for complete list of fenders and additional color, material, and lightbox options.

AN AMERICAN FAMILY OWNED COMPANY FOR 30 YEARS

MINIMIZER.COM

800.248.3855

DOUBLE DEUCE

"Here's some pictures of my new truck. I love the way the fenders follow the profile of the wheels."

TANDEM AXLE FENDERS **SPECS**

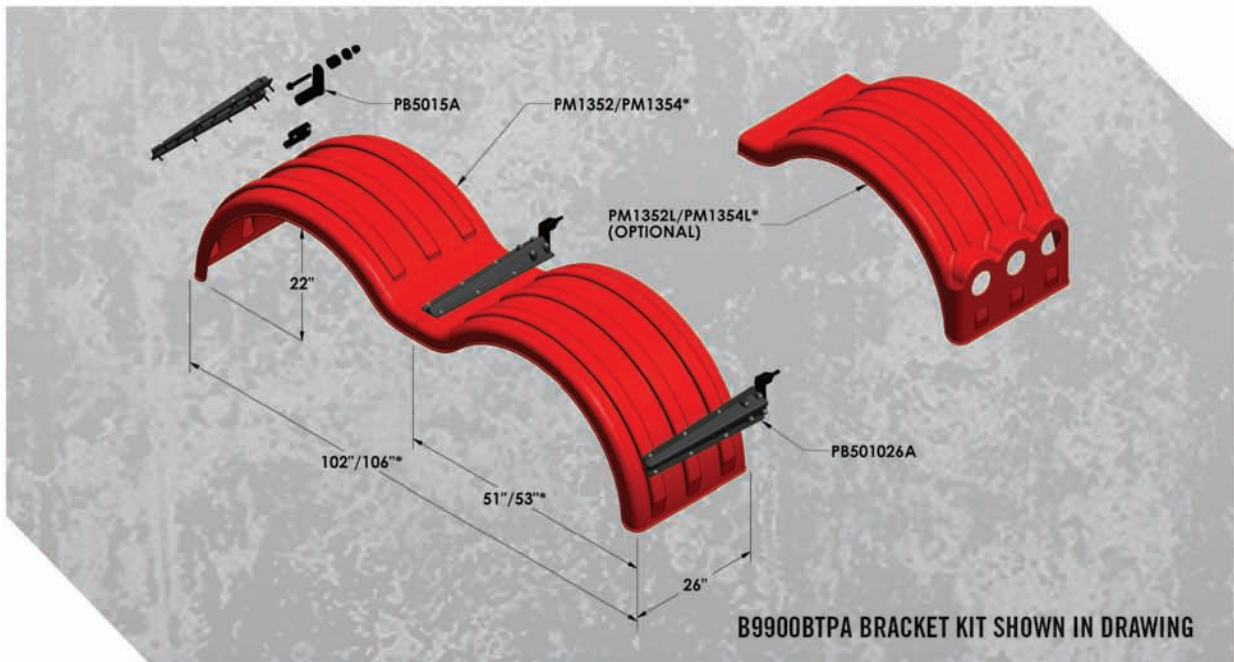

INSTALLATION **KITS**

- B9900**BTPA** - Black Plastic Bolt-on Kit
- B9900**BTPACF** - Carbon Fiber Plastic Bolt-on Kit
- B9900**BTPACHROME** - Chrome Plastic Bolt-on Kit
- B9900**BTPAPL** - Liquid Platinum Plastic Bolt-on Kit
- B9900**PBA** - Plastic Paddle Bracket Bolt-on Kit
- B9900**BTSA** - Stainless Bolt-on Kit
- B9900**WOA** - Weld-on Kit

SEE **PAGE 79-80** FOR MORE INFORMATION ON AVAILABLE INSTALLATION KITS

MIN 1500/1554



Full Tandem Axle Set

SQUARE BACK **BRUISER**

- MIN1500/1554 is designed to fit a tandem axle tractor or trailer with either a 52" or 54" axle spread.
- The set consists of 4 pieces (4 - PM1501 single fenders).
- The total weight of the MIN1500/1554 fender kit is less than 45 pounds.
- See page 77 for complete list of fenders and additional color, material, and lightbox options.

AN AMERICAN FAMILY OWNED COMPANY FOR 30 YEARS

MINIMIZER.COM

800.248.3855

BACK BRUISER

"I wanted something that had the same square-backed look as my truck. This model seems to fit the bill."

TANDEM AXLE FENDERS **SPECS**

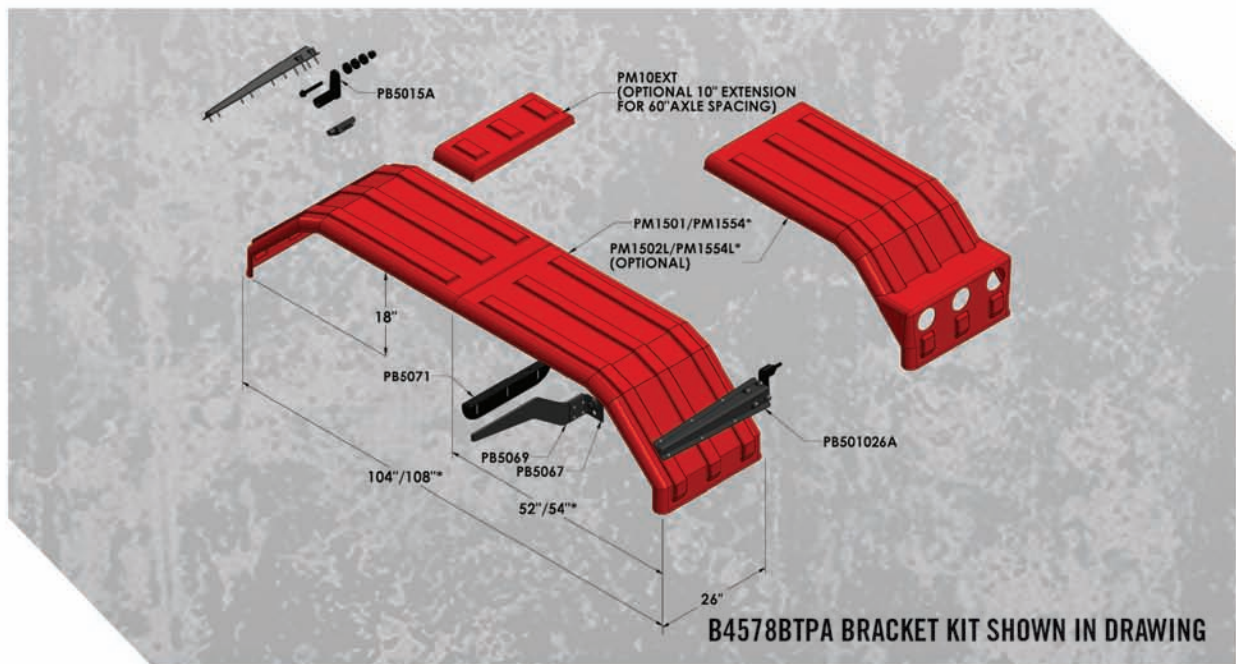

INSTALLATION **KITS**

- **B4578BTPA** - Black Plastic Bolt-on Kit
- **B4578BTPACF** - Carbon Fiber Plastic Bolt-on Kit
- **B4578BTPACHROME** - Chrome Plastic Bolt-on Kit
- **B4578BTPAPL** - Liquid Platinum Plastic Bolt-on Kit
- **B4578PBA** - Plastic Paddle Bracket Bolt-on Kit
- **B4578BTSA** - Stainless Bolt-on Kit
- **B4578WOA** - Weld-on Kit

SEE **PAGE 79-80** FOR MORE INFORMATION ON AVAILABLE INSTALLATION KITS

MIN 150



**Multiple Axle Set:
Dual Wheels Up to 24.5"**

THE **EYEBROW**

- MIN150 is designed to fit 22.5" or 24.5" tractor or trailer wheels.
- The set consists of 2 pieces (2 - PM151 single fenders).
- The total weight of the MIN150 fender kit is less than 17 pounds.
- See page 77 for complete list of fenders and additional color, material, and lightbox options.

AN AMERICAN FAMILY OWNED COMPANY FOR 30 YEARS

MINIMIZER.COM

800.248.3855

THE EYEBROW

"My experiences with both the company and the product were terrific."

MULTIPLE AXLE FENDERS **SPECS**

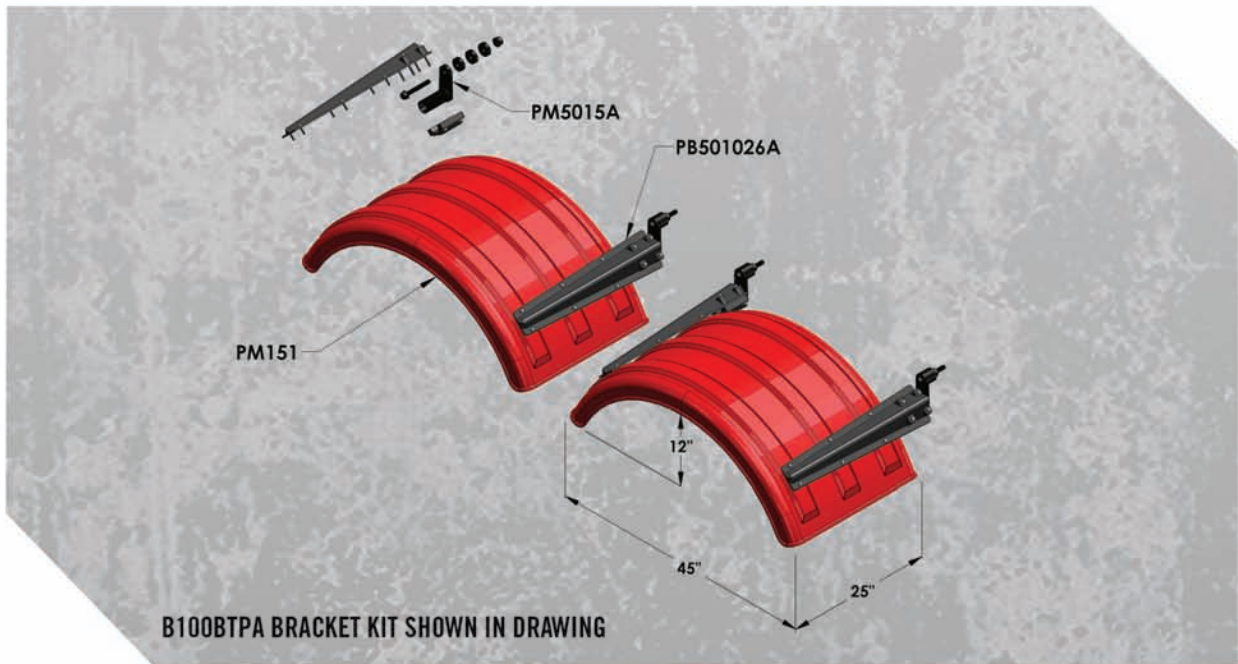

INSTALLATION **KITS**

- B100**BTPA** - Black Plastic Bolt-on Kit
- B100**BTPACF** - Carbon Fiber Plastic Bolt-on Kit
- B100**BTPACHROME** - Chrome Plastic Bolt-on Kit
- B100**BTPAPL** - Liquid Platinum Plastic Bolt-on Kit
- B100**PBA** - Plastic Paddle Bracket Bolt-on Kit
- B100**BTSA** - Stainless Bolt-on Kit
- B100**WOA** - Weld-on Kit

SEE **PAGE 79-80** FOR MORE INFORMATION ON AVAILABLE INSTALLATION KITS

MIN 2260



THE TT TWIN

Multiple Axle Set:
Dual 22.5" and 24.5" Wheels

- MIN2260 is designed to fit a single axle tractor or trailer with 22.5" or 24.5" wheels.
- The set consists of 2 pieces (2 - PM2261 single fenders).
- The total weight of the MIN2260 fender kit is less than 24 pounds.
- See page 77 for complete list of fenders and additional color, material, and lightbox options.

AN AMERICAN FAMILY OWNED COMPANY FOR 30 YEARS

MINIMIZER.COM

800.248.3855

THE TT TWIN

"I'm impressed with the 'showroom like' looks after thousands of miles on the road and years of abuse."

MULTIPLE AXLE FENDERS **SPECS**

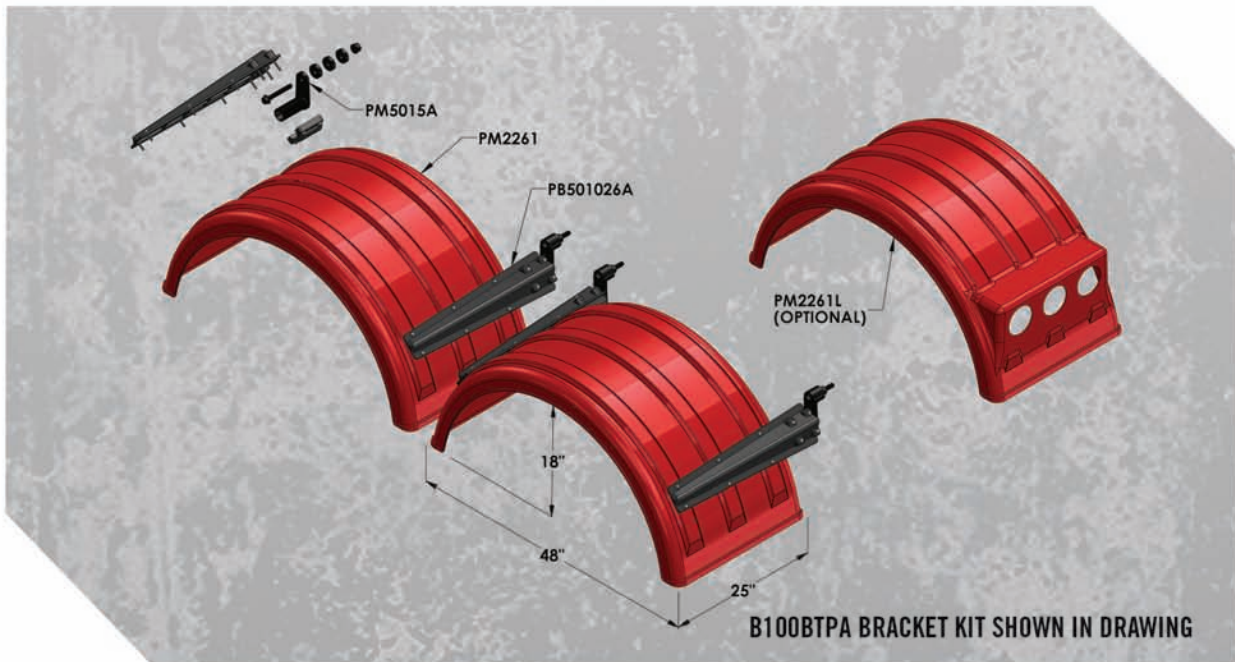

INSTALLATION **KITS**

- B100**BTPA** - Black Plastic Bolt-on Kit
- B100**BTPACF** - Carbon Fiber Plastic Bolt-on Kit
- B100**BTPACHROME** - Chrome Plastic Bolt-on Kit
- B100**BTPAPL** - Liquid Platinum Plastic Bolt-on Kit
- B100**PBA** - Plastic Paddle Bracket Bolt-on Kit
- B100**B TSA** - Stainless Bolt-on Kit
- B100**WOA** - Weld-on Kit

SEE **PAGE 79-80** FOR MORE INFORMATION ON AVAILABLE INSTALLATION KITS

MIN 2480

THE



THE TEXAS **DOUBLE**

**Multiple Axle Set:
Dual 24.5" Wheels**

- MIN2480 is designed to fit a single axle with 24.5" tractor or trailer wheels.
- The set consists of 2 pieces (2 - PM2481 single fenders).
- The total weight of the MIN2480 fender kit is less than 26 pounds.
- See page 77 for complete list of fenders and additional color, material, and lightbox options.

AN AMERICAN FAMILY OWNED COMPANY FOR 30 YEARS

MINIMIZER.COM

800.248.3855

TEXAS DOUBLE

"I love the way the fenders wrap around the tire for complete coverage."

MULTIPLE AXLE FENDERS **SPECS**

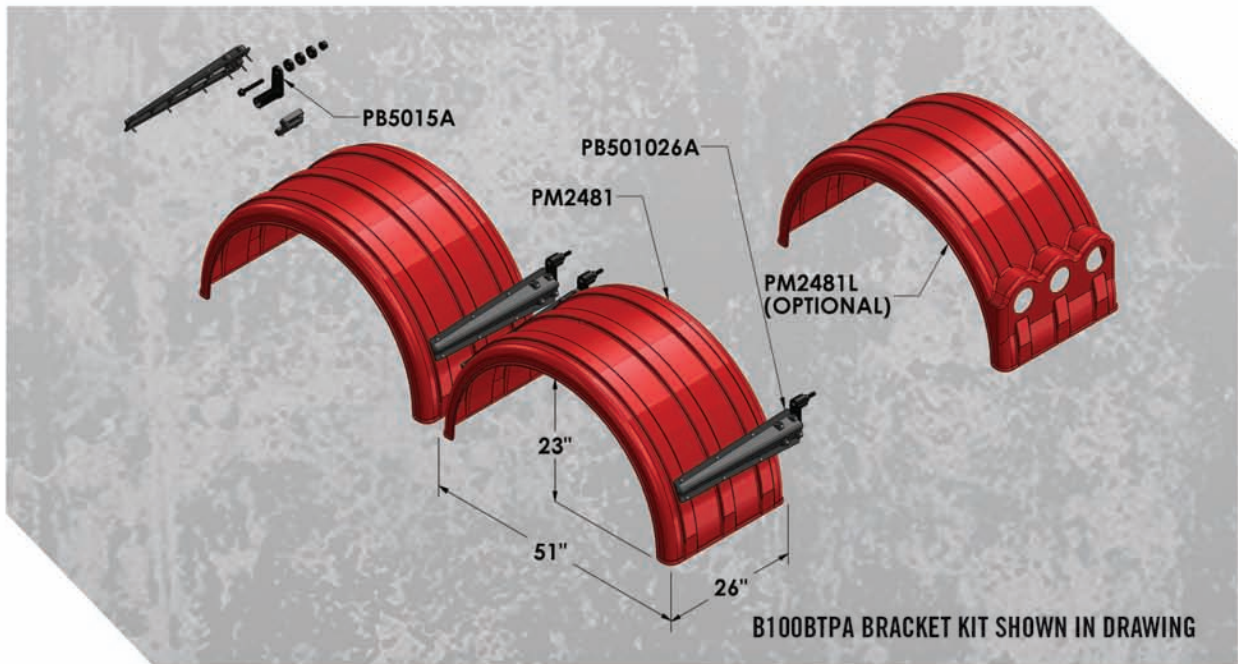

INSTALLATION **KITS**

- B100**BTPA** - Black Plastic Bolt-on Kit
- B100**BTPACF** - Carbon Fiber Plastic Bolt-on Kit
- B100**BTPACHROME** - Chrome Plastic Bolt-on Kit
- B100**BTPAPL** - Liquid Platinum Plastic Bolt-on Kit
- B100**PBA** - Plastic Paddle Bracket Bolt-on Kit
- B100**B TSA** - Stainless Bolt-on Kit
- B100**WOA** - Weld-on Kit

SEE **PAGE 79-80** FOR MORE INFORMATION ON AVAILABLE INSTALLATION KITS

MIN 300

THE

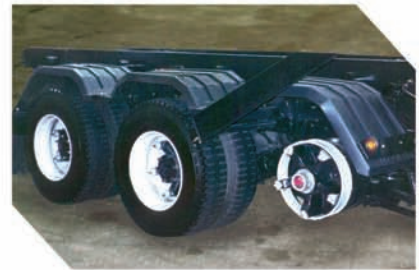

Tri-Axle Set

THE TRIPLE **THREAT**

- MIN300 is designed to fit a tri-axle tractor or trailer.
- The set consists of 6 pieces (4 - PM201 front and rear sections and 2 - PM301 center sections).
- The total weight of the MIN300 fender kit is less than 55 pounds.
- Optional trim plates are available.
- See page 77 for complete list of fenders and additional color, material, and lightbox options.

AN AMERICAN FAMILY OWNED COMPANY FOR 30 YEARS

MINIMIZER.COM

800.248.3855

TRIPLE THREAT

"The first time a gooseneck rubbed these, I thought they were trashed. When I jumped out and looked, I couldn't even tell they'd been hit!"

MULTIPLE AXLE FENDERS **SPECS**

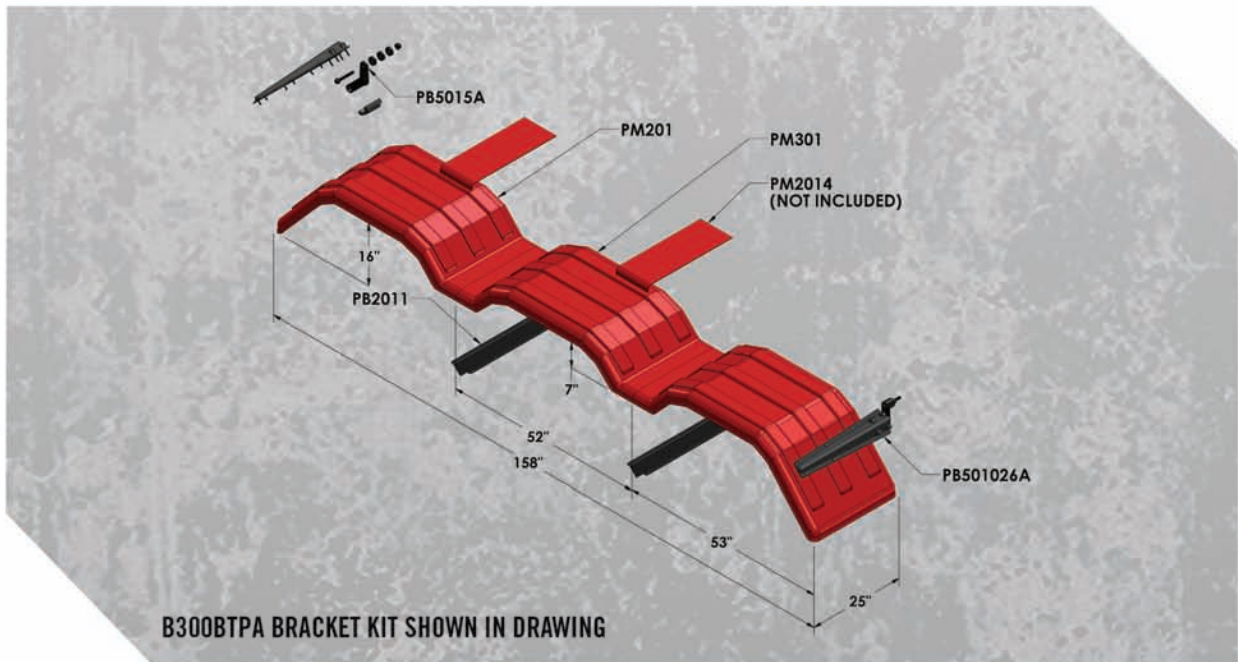

INSTALLATION **KITS**

- B300BTBA - Black Plastic Bolt-on Kit
- B300BTPACF - Carbon Fiber Plastic Bolt-on Kit
- B300BTPACHROME - Chrome Plastic Bolt-on Kit
- B300BTPAPL - Liquid Platinum Plastic Bolt-on Kit
- B300PBA - Plastic Paddle Bracket Bolt-on Kit
- B300WOA - Weld-on Kit

SEE **PAGE 79-80** FOR MORE INFORMATION ON AVAILABLE INSTALLATION KITS

MIN 318

R



Tri-Axle Fenders Set With Single Wheel Pushers

ROLLING TRIPLES

- MIN318 is designed to fit a tri-axle tractor or trailer with a single wheel pusher axle.
- The set consists of 6 pieces (2 - PM201 rear sections, 2 - PM301 center sections and 2 - PM218 front sections).
- The total weight of the MIN318 fender kit is less than 51 pounds.
- See page 77 for complete list of fenders and additional color, material, and lightbox options.

AN AMERICAN FAMILY OWNED COMPANY FOR 30 YEARS

MINIMIZER.COM

800.248.3855

ROLLING TRIPLES

"I've heard these fenders were for garbage trucks. Funny thing is, the only garbage I've ever had on my rig were my previous metal fenders."

MULTIPLE AXLE FENDERS **SPECS**

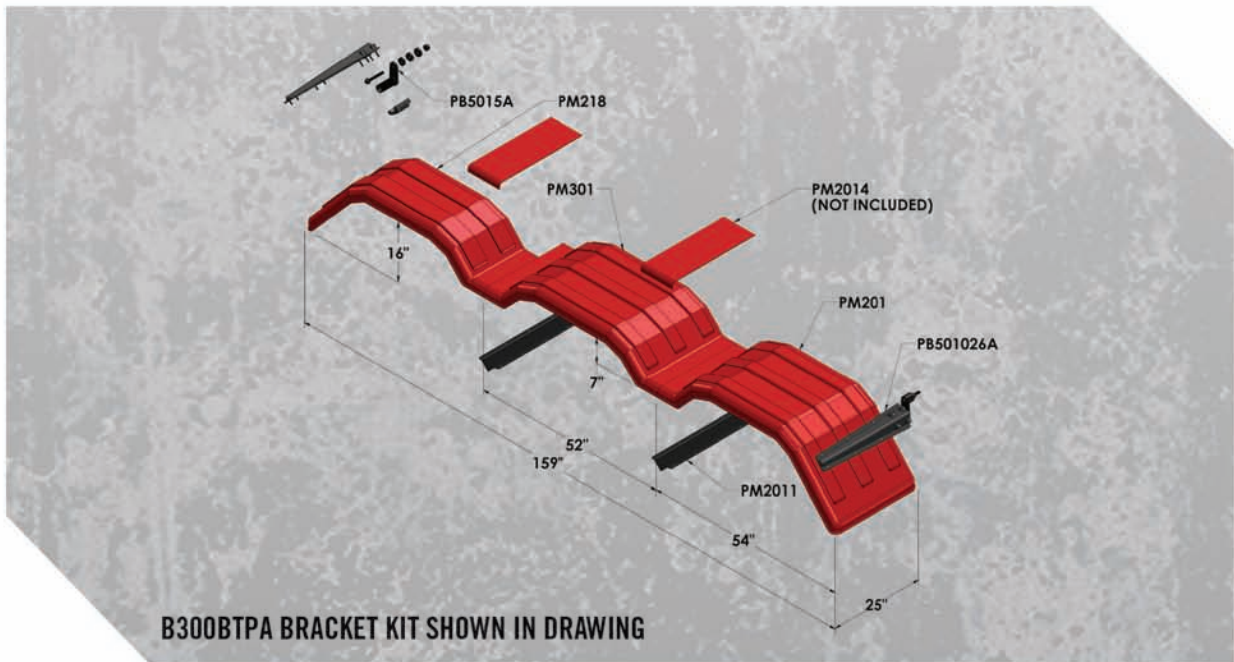

INSTALLATION **KITS**

- B300**BTPA** - Black Plastic Bolt-on Kit
- B300**BTPACF** - Carbon Fiber Plastic Bolt-on Kit
- B300**BTPACHROME** - Chrome Plastic Bolt-on Kit
- B300**BTPAPL** - Liquid Platinum Plastic Bolt-on Kit
- B300**PBA** - Plastic Paddle Bracket Bolt-on Kit
- B300**WOA** - Weld-on Kit

SEE **PAGE 79-80** FOR MORE INFORMATION ON AVAILABLE INSTALLATION KITS

MINTA1554

THE

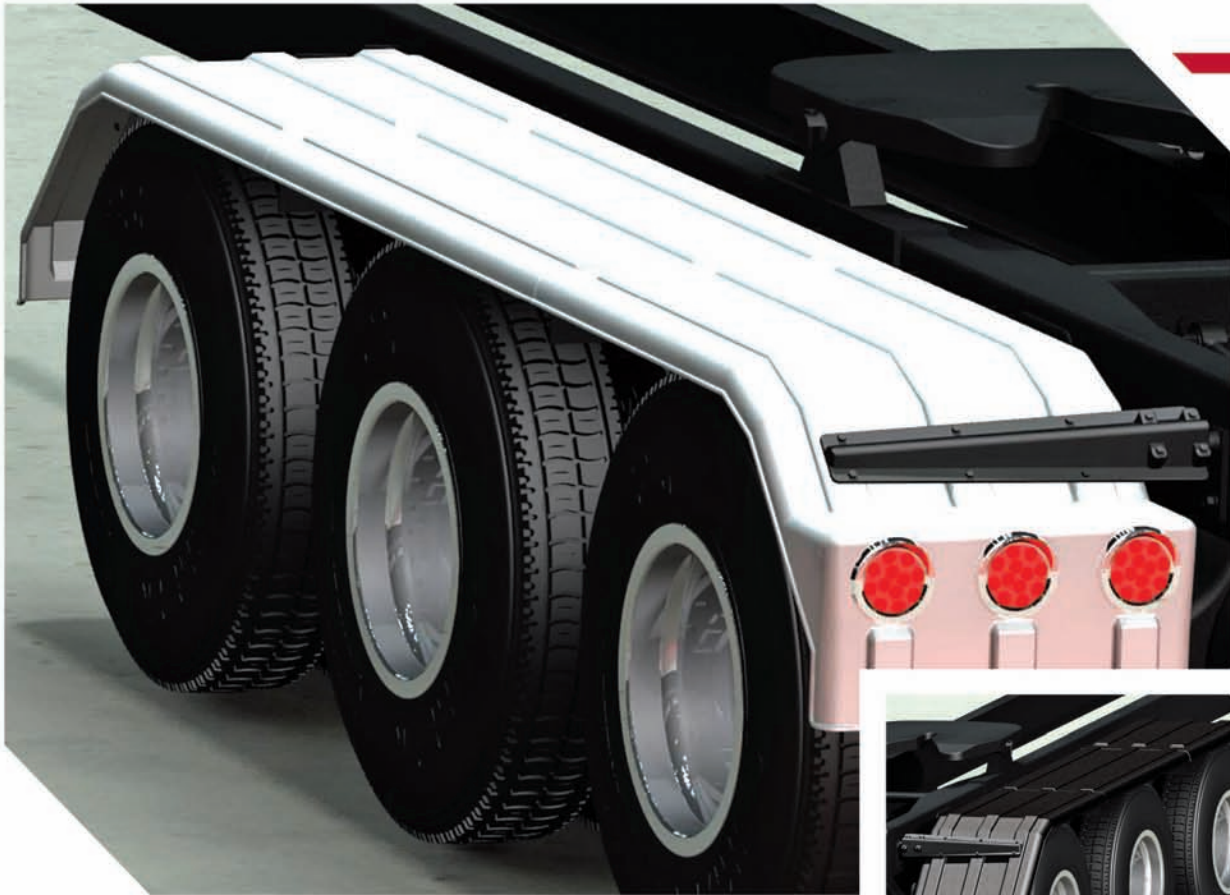

Tri-Axle Fenders Set

THE LONG **SHOT**

- MINTA1554 is designed to fit a tri-axle tractor or trailer.
- The set consists of 6 pieces (4 - PM1554 front and rear sections, 2 - PMTA53 center sections).
- The total weight of the MINTA1554 fender kit is less than 80 pounds.
- See page 77 for complete list of fenders and additional color, material, and lightbox options.

AN AMERICAN FAMILY OWNED COMPANY FOR 30 YEARS

MINIMIZER.COM

800.248.3855

LONG SHOT

“Concrete doesn’t even stick to my fenders, I just hose them off and they look brand new again.”

MULTIPLE AXLE FENDERS **SPECS**

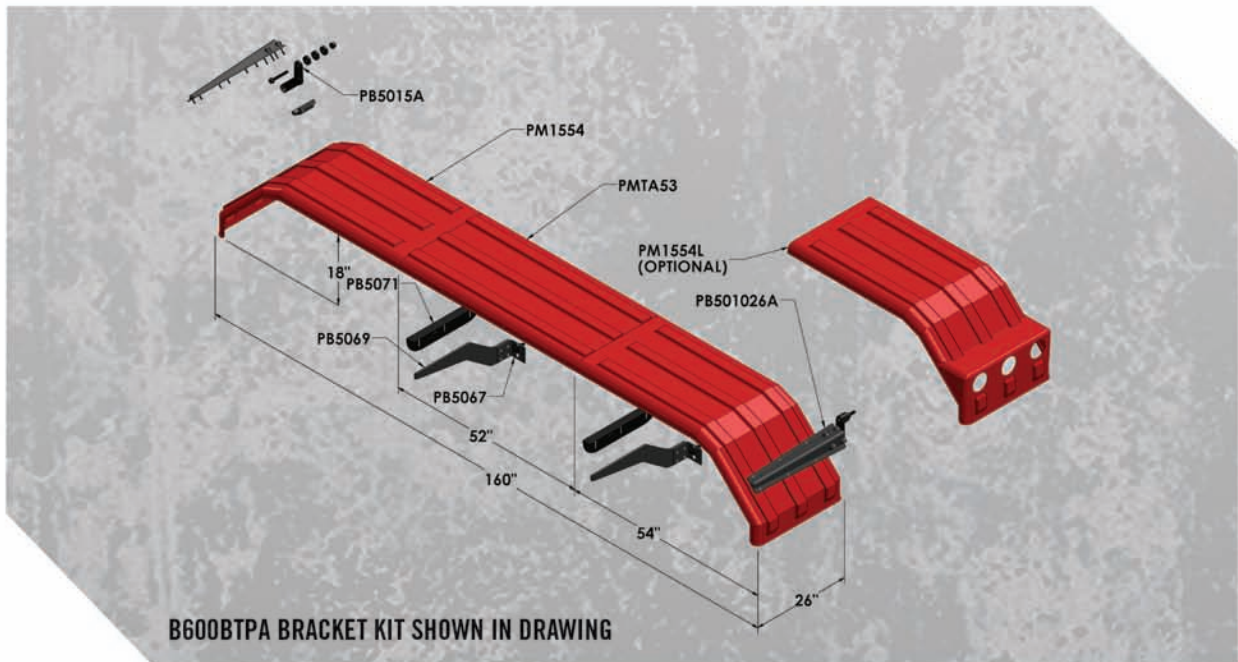

INSTALLATION **KITS**

- B600**BTPA** - Black Plastic Bolt-on Kit
- B600**BTPACF** - Carbon Fiber Plastic Bolt-on Kit
- B600**BTPACHROME** - Chrome Plastic Bolt-on Kit
- B600**BTPAPL** - Liquid Platinum Plastic Bolt-on Kit
- B600**PBA** - Plastic Paddle Bracket Bolt-on Kit
- B600**BTSA** - Stainless Bolt-on Kit
- B600**WOA** - Weld-on Kit

SEE **PAGE 79-80** FOR MORE INFORMATION ON AVAILABLE INSTALLATION KITS

MINTA910

LONG



Tri-Axle Fenders Set

LONG & STREAMLINED

- MINTA910 is designed to fit a tri-axle tractor or trailer.
- The set consists of 6 pieces (4 - PM901 front and rear sections and 2 PMTA53 center sections).
- The total weight of the MINTA910 fender kit is less than 80 pounds.
- See page 77 for complete list of fenders and additional color, material, and lightbox options.

AN AMERICAN FAMILY OWNED COMPANY FOR 30 YEARS

MINIMIZER.COM

800.248.3855

& STREAMLINED

"I can't believe fenders that look this good can take what my work day dishes out."

MULTIPLE AXLE FENDERS **SPECS**

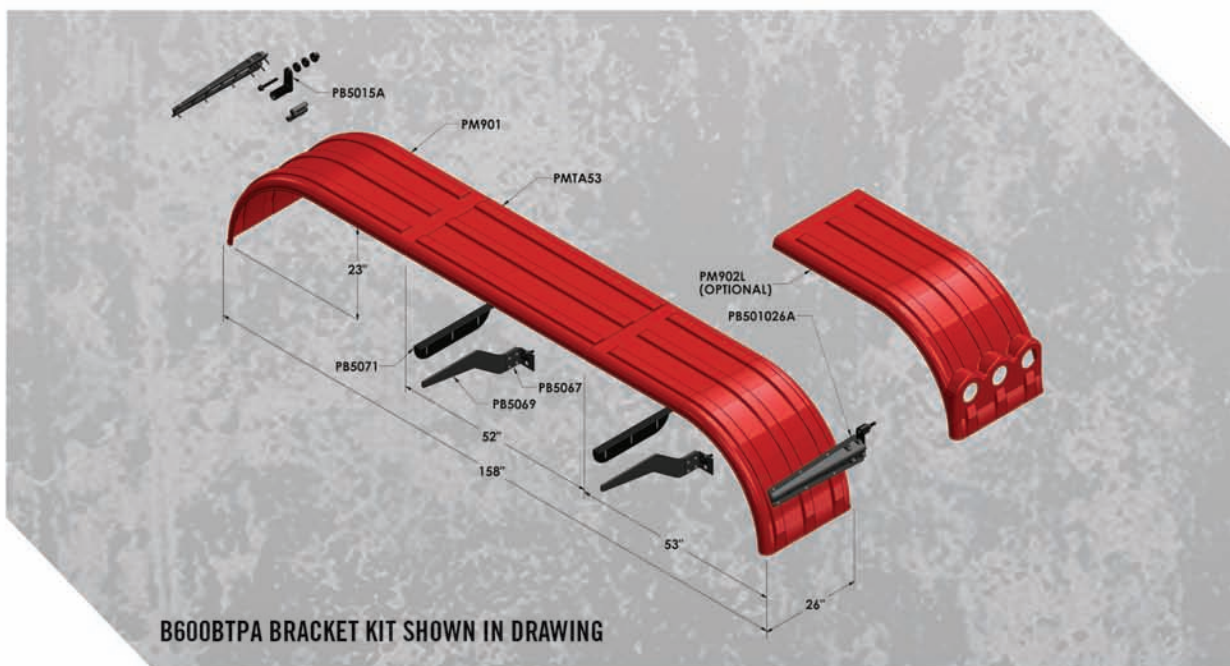

INSTALLATION **KITS**

- B600**BTPA** - Black Plastic Bolt-on Kit
- B600**BTPACF** - Carbon Fiber Plastic Bolt-on Kit
- B600**BTPACHROME** - Chrome Plastic Bolt-on Kit
- B600**BTPAPL** - Liquid Platinum Plastic Bolt-on Kit
- B600**PBA** - Plastic Paddle Bracket Bolt-on Kit
- B600**B TSA** - Stainless Bolt-on Kit
- B600**WOA** - Weld-on Kit

SEE **PAGE 79-80** FOR MORE INFORMATION ON AVAILABLE INSTALLATION KITS

MIN 202/302/1021



Tri-Axle Fenders Set With Single Wheel Pushers

THE TRASHER

- PM202/302/1021 are designed to fit a tandem axle tractor or trailer with a single wheel pusher axle.
- The fender set is sold per individual piece. The rear section is the PM202, center section is the PM302 and the front single wheel section is the PM1021.
- The total weight of the PM202/302/1021 fender set is less than 44 pounds for all 6 pieces.
- See page 77 for complete list of fenders and additional color, material, and lightbox options.

AN AMERICAN FAMILY OWNED COMPANY FOR 30 YEARS

MINIMIZER.COM

800.248.3855

THE TRASHER

“Do yourself, and your truck, a favor and let the Minimizer make a believer out of you.”

MULTIPLE AXLE FENDERS **SPECS**

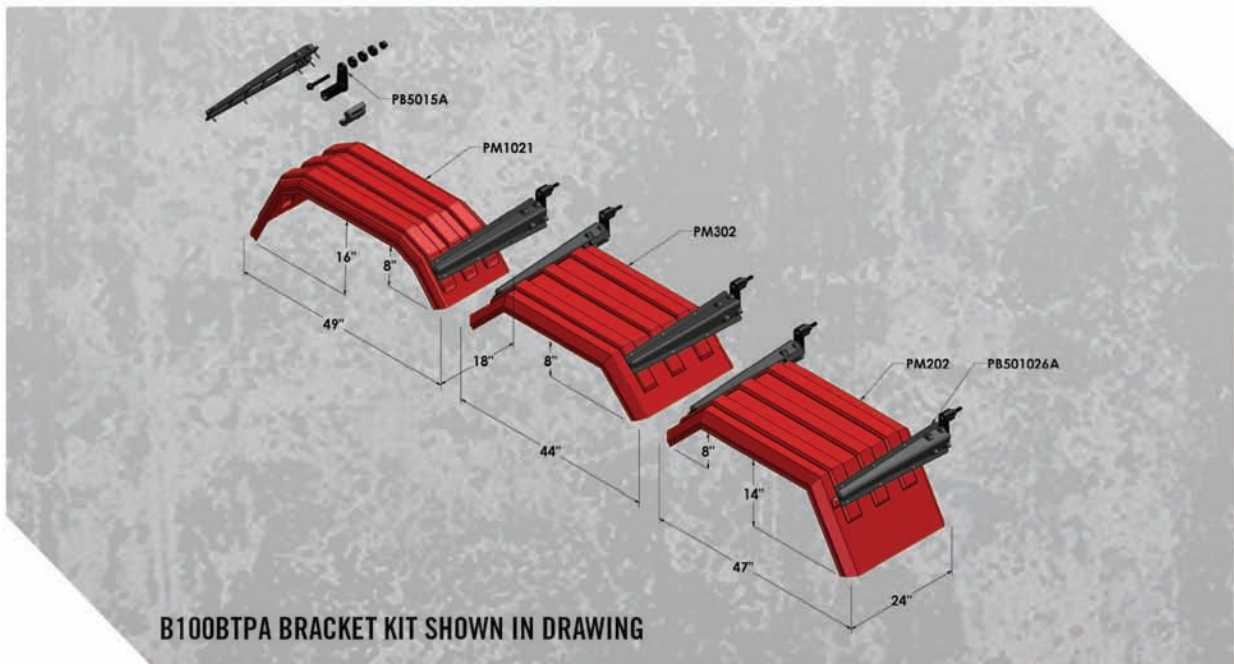

INSTALLATION **KITS**

- B100**BTPA** - Black Plastic Bolt-on Kit
- B100**BTPACF** - Carbon Fiber Plastic Bolt-on Kit
- B100**BTPACHROME** - Chrome Plastic Bolt-on Kit
- B100**BTPAPL** - Liquid Platinum Plastic Bolt-on Kit
- B100**PBA** - Plastic Paddle Bracket Bolt-on Kit
- B100**BTSA** - Stainless Bolt-on Kit
- B100**WOA** - Weld-on Kit

SEE **PAGE 79-80** FOR MORE INFORMATION ON AVAILABLE INSTALLATION KITS

500 MINIMIZER WAY SE, BLOOMING PRAIRIE, MN 55917



MIN 4050

THE

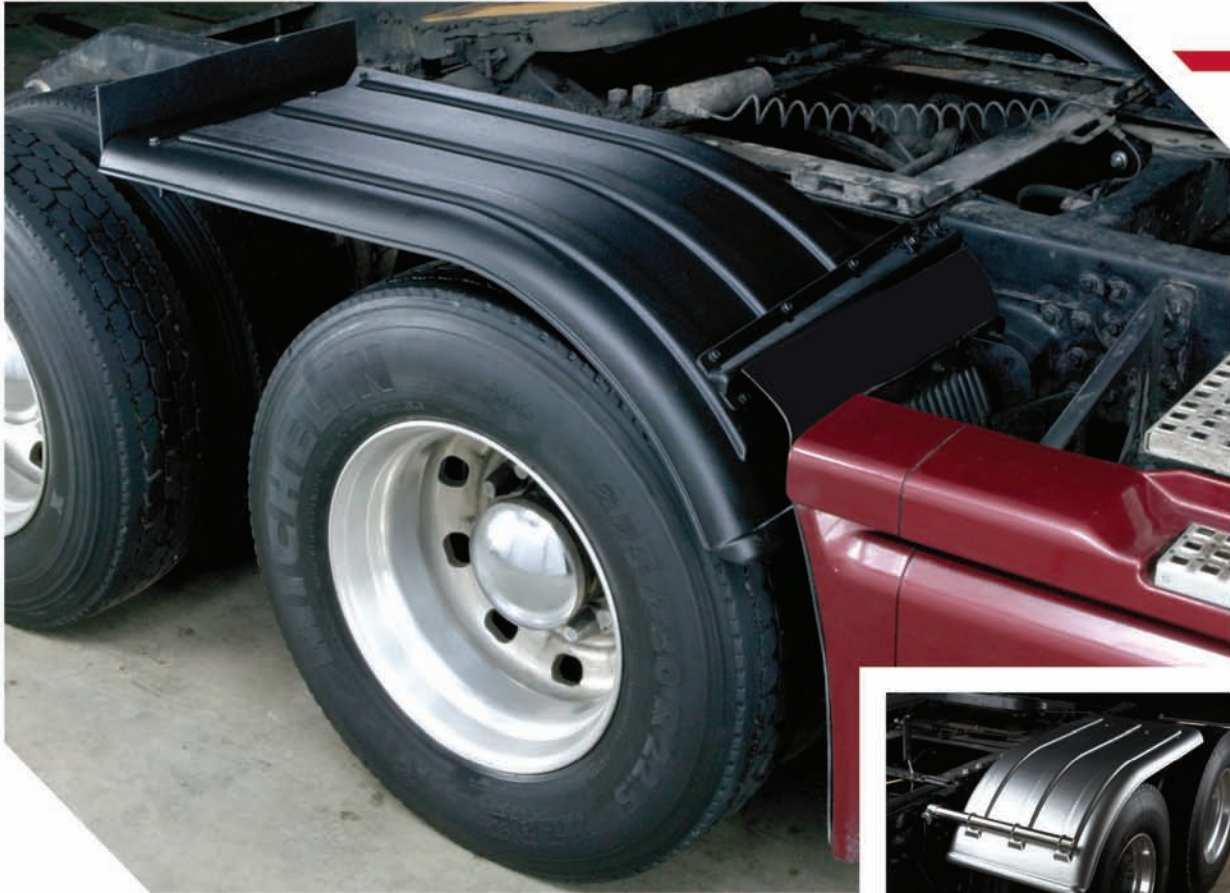

Half Fenders Set

THE HALF HORSE

- MIN4050 is designed to fit a tandem axle tractor or trailer as a half fender.
- The set consists of 2 pieces (2 - PM4001 fender sections).
- The total weight of the MIN4050 fender kit is less than 23 pounds.
- Optional splash guards are available.
- See page 77 for complete list of fenders and additional color, material, and lightbox options.

AN AMERICAN FAMILY OWNED COMPANY FOR 30 YEARS

MINIMIZER.COM

800.248.3855

HALF HORSE

"The back of my day cab has never looked so nice."

HALF FENDERS **SPECS**

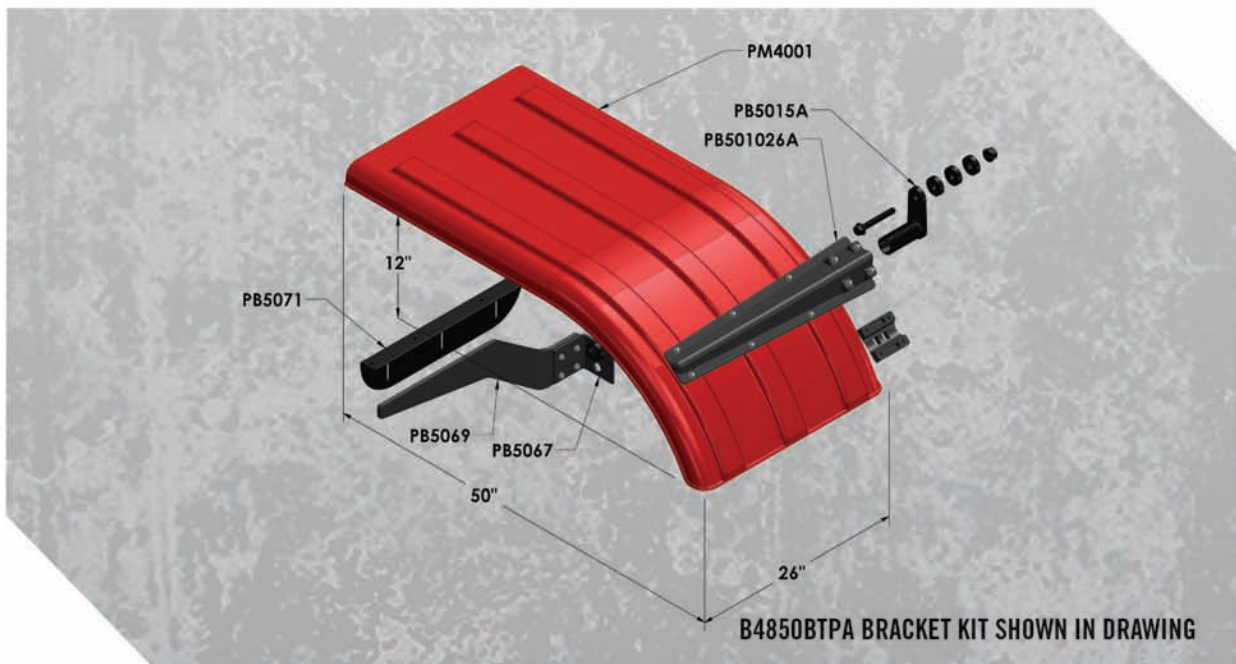

INSTALLATION **KITS**

- B4850**BTPA** - Black Plastic Bolt-on Kit
- B4850**BTPACF** - Carbon Fiber Plastic Bolt-on Kit
- B4850**BTPACHROME** - Chrome Plastic Bolt-on Kit
- B4850**BTPAPL** - Liquid Platinum Plastic Bolt-on Kit
- B4850**PBA** - Plastic Paddle Bracket Bolt-on Kit
- B4850**BTSA** - Stainless Bolt-on Kit
- B4850**WOA** - Weld-on Kit

SEE **PAGE 79-80** FOR MORE INFORMATION ON AVAILABLE INSTALLATION KITS

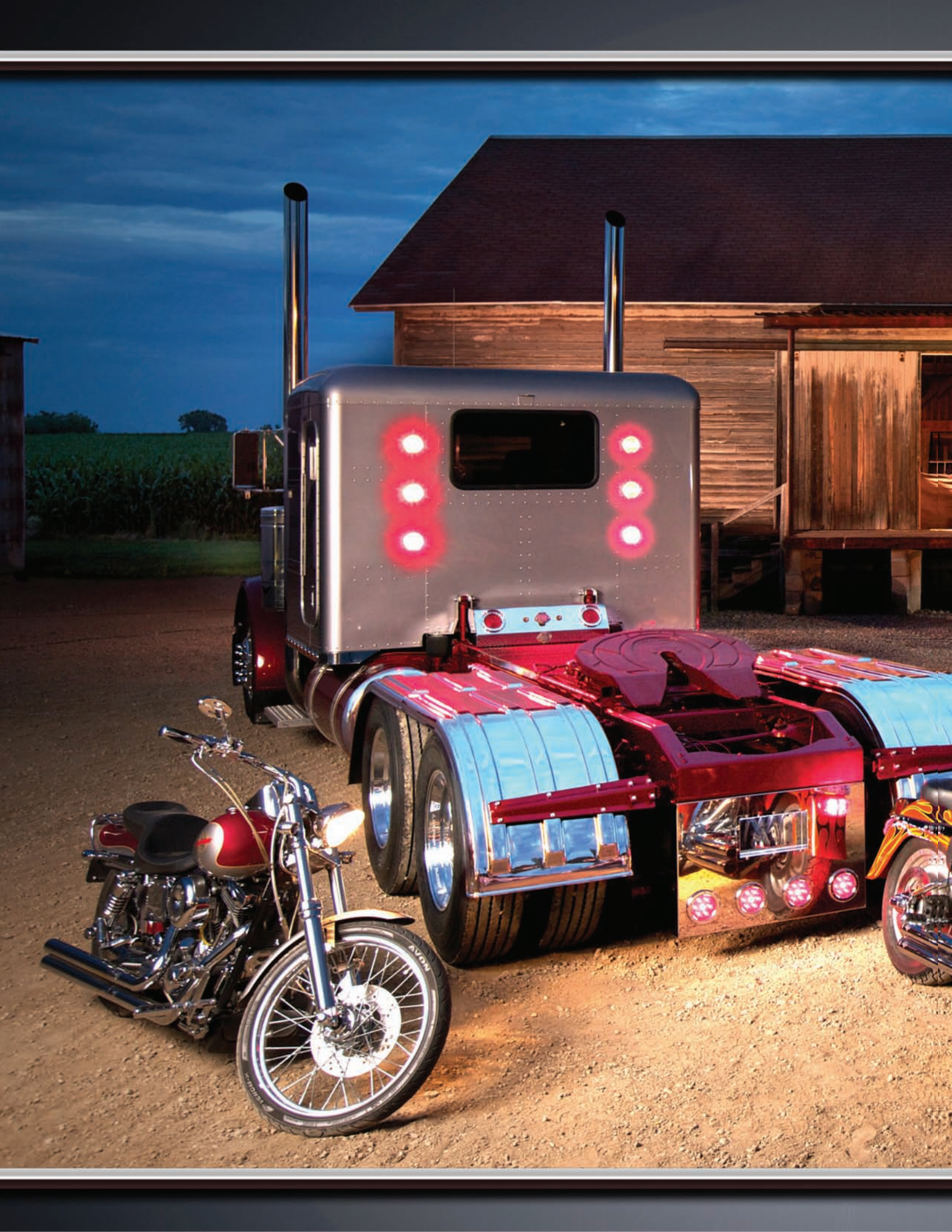



MIN 950

THE



Half Fenders Set

THE BRUTE **HALF**

- MIN950 is designed to fit a tandem axle tractor or trailer as a half fender.
- The set consists of 2 pieces (2 - PM901 fender sections).
- The total weight of the MIN950 fender kit is less than 26 pounds.
- Optional splash guard available.
- See page 77 for complete list of fenders and additional color, material, and lightbox options.

AN AMERICAN FAMILY OWNED COMPANY FOR 30 YEARS

MINIMIZER.COM

800.248.3855

BRUTE HALF

“My lowboy trailer has come down on my fenders several times, but you’d never know it by lookin’ at them.”

HALF FENDERS **SPECS**

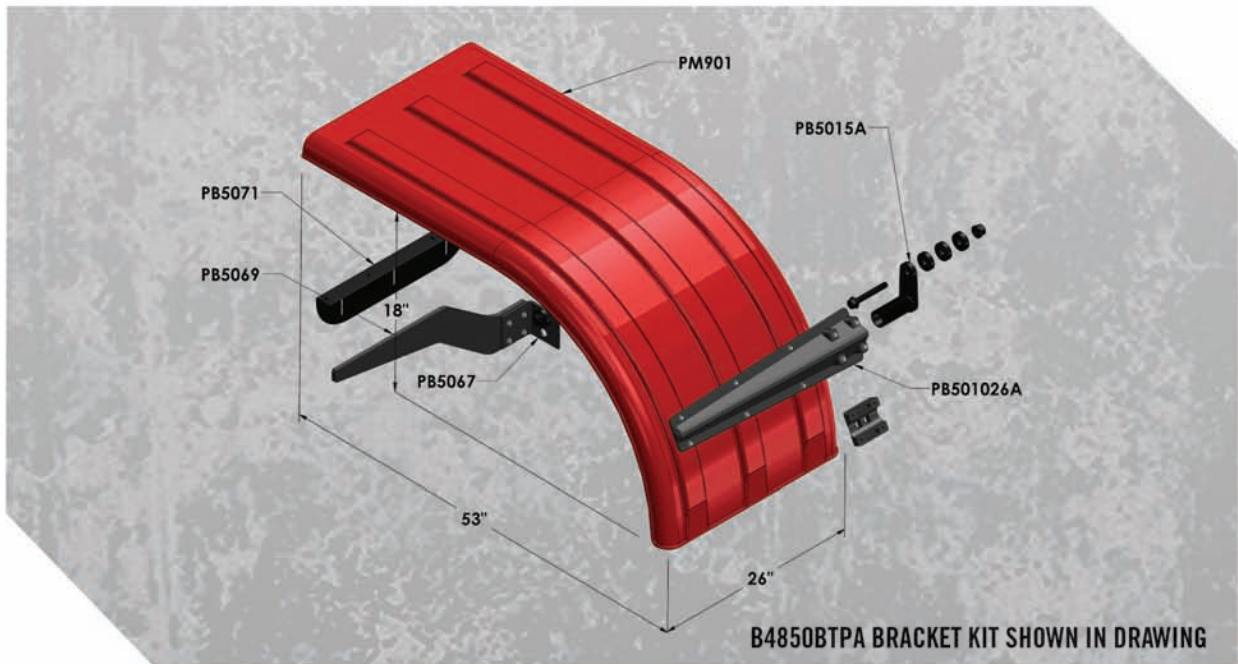

INSTALLATION **KITS**

- B4850**BTPA** - Black Plastic Bolt-on Kit
- B4850**BTPACF** - Carbon Fiber Plastic Bolt-on Kit
- B4850**BTPACHROME** - Chrome Plastic Bolt-on Kit
- B4850**BTPAPL** - Liquid Platinum Plastic Bolt-on Kit
- B4850**PBA** - Plastic Paddle Bracket Bolt-on Kit
- B4850**BTSA** - Stainless Bolt-on Kit
- B4850**WOA** - Weld-on Kit

SEE **PAGE 79-80** FOR MORE INFORMATION ON AVAILABLE INSTALLATION KITS

MIN 1550

SQU



Half Fenders Set

SQUARE BACK **HALF**

- MIN1550 is designed to fit a tandem axle tractor or trailer as a half fender.
- The set consists of 2 pieces (2 – PM1501 fender sections).
- The total weight of the MIN1550 is less than 22 pounds.
- Optional splash guard available.
- See page 77 for complete list of fenders and additional color, material, and lightbox options.

AN AMERICAN FAMILY OWNED COMPANY FOR 30 YEARS

MINIMIZER.COM

800.248.3855

ARE BACK HALF

"I love the coverage these half fenders provide, they really protect the back of my truck."

HALF FENDERS **SPECS**

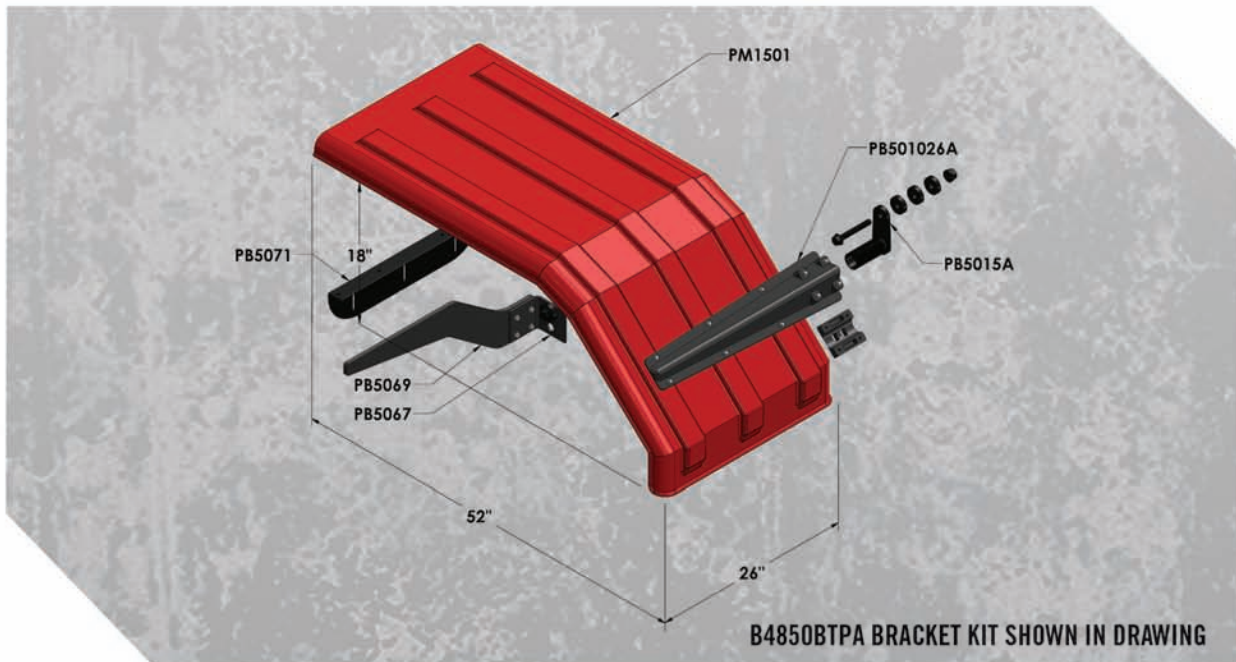

INSTALLATION **KITS**

- B4850**BTPA** - Black Plastic Bolt-on Kit
- B4850**BTPACF** - Carbon Fiber Plastic Bolt-on Kit
- B4850**BTPACHROME** - Chrome Plastic Bolt-on Kit
- B4850**BTPAPL** - Liquid Platinum Plastic Bolt-on Kit
- B4850**PBA** - Plastic Paddle Bracket Bolt-on Kit
- B4850**BTSA** - Stainless Bolt-on Kit
- B4850**WOA** - Weld-on Kit

SEE **PAGE 79-80** FOR MORE INFORMATION ON AVAILABLE INSTALLATION KITS

MIN **ARMADILLO**



THE **ARMADILLO**

- Ideal for keeping mud off operator's windows and mirrors. Improve your organization's safety record by keeping operator's area protected.
- Forever shape™ pops back after impact. It will not stress crack. Fits on applications where metal fenders are simply not practical.
- Superior control of water spray and rocks keep equipment and loads cleaner.
- Please reference Part# PM1100B

AN AMERICAN FAMILY OWNED COMPANY FOR 30 YEARS

MINIMIZER.COM

800.248.3855

THE ARMADILLO

"I love the product so much I bought the company!"

CONSTRUCTION & UTILITY FENDERS **SPECS**



MIN **G1000** CONSTRU



THE **G1000**

- Ideal for keeping mud off operator's windows and mirrors. Improve your organization's safety record by keeping operator's area protected.
- Forever shape™ pops back after impact. It will not stress crack.
- Superior control of water spray and rocks keep equipment and loads cleaner.
- Please reference Part# PCG1000B.

AN AMERICAN FAMILY OWNED COMPANY FOR 30 YEARS

MINIMIZER.COM

800.248.3855

CTION FENDERS

"I love the product so much I bought the company!"

CONSTRUCTION & UTILITY FENDERS **SPECS**

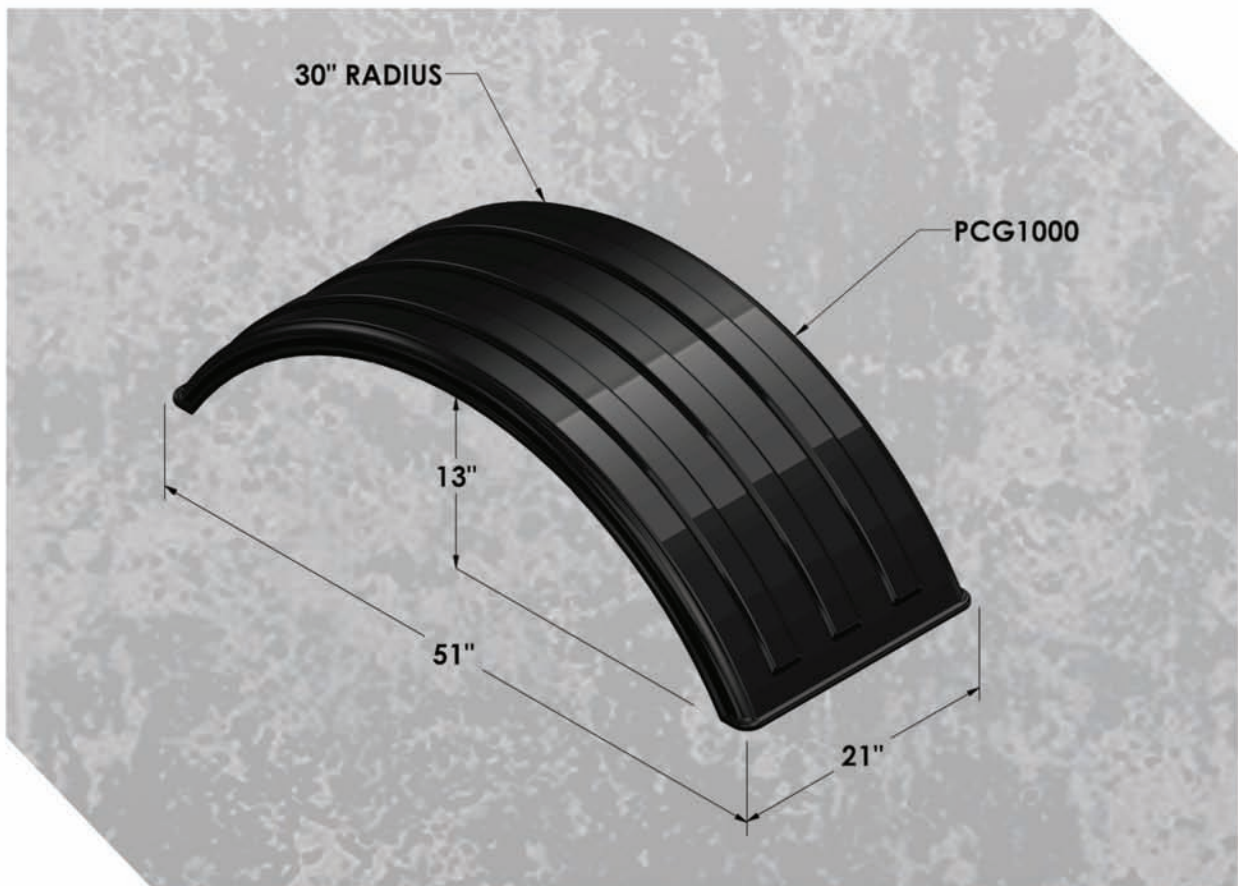

500 MINIMIZER WAY SE, BLOOMING PRAIRIE, MN 55917



MIN **AUXILIARY LIFT**

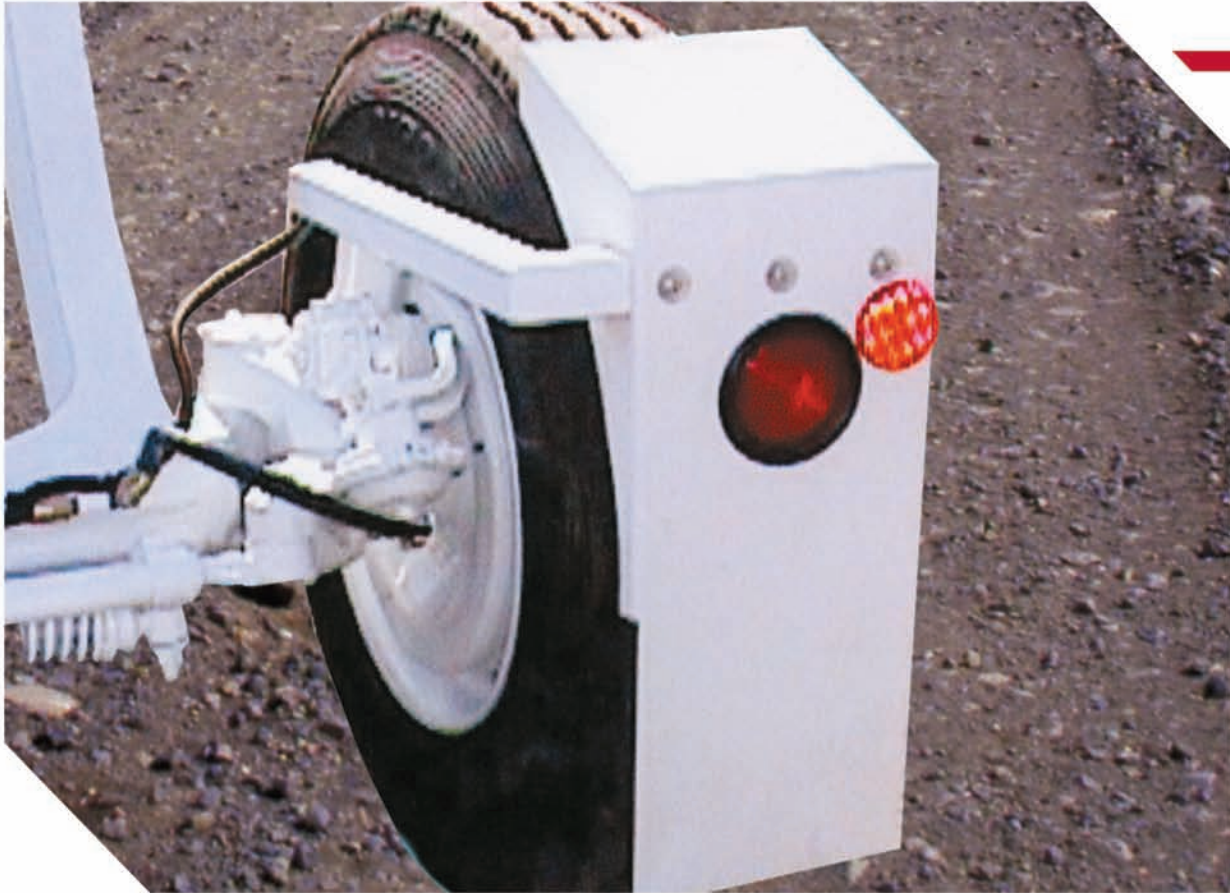

THE **AUXILIARY LIFT**

- Ideal for keeping mud off operator's windows and mirrors. Improve your organization's safety record by keeping operator's area protected.
- Forever shape™ pops back after impact. It will not stress crack. Fits on applications where metal fenders are simply not practical.
- Superior control of water spray and rocks keep equipment and loads cleaner.
- Please reference Part# PMC10R - Curbside and/or PMC10L - Road Side

AN AMERICAN FAMILY OWNED COMPANY FOR 30 YEARS

MINIMIZER.COM

800.248.3855

AUXILIARY LIFT

"I couldn't believe all the hype about these fenders until I tried them out for myself!"

CONSTRUCTION & UTILITY FENDERS **SPECS**

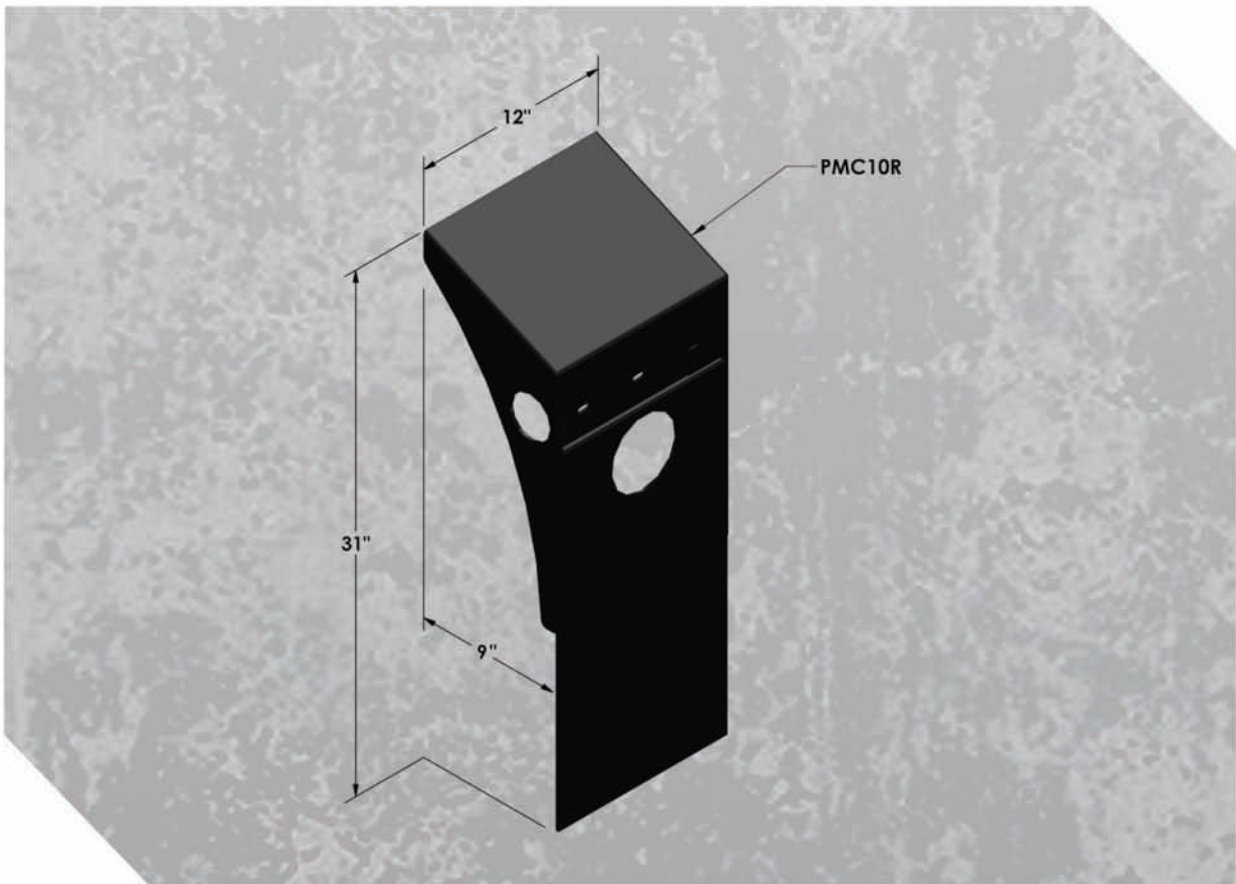

MIN 161200



THE LONER

- MIN161200 is designed to fit a single tractor or trailer 16.5" tire up to a low - profile 22.5" tire (255 70R 22.5).
- The set consists of 2 pieces (2-PM1612 fender sections).
- Works great for steerable axles.
- The total weight of the MIN161200 fender kit is less than 12 pounds.
- See page 77 for complete list of fenders and additional color, material, and lightbox options.

AN AMERICAN FAMILY OWNED COMPANY FOR 30 YEARS

MINIMIZER.COM

800.248.3855

THE LONER

"In the past the vibration tore up my aluminum fenders. Now, my fenders are outlasting my truck."

SINGLE WHEEL FENDERS **SPECS**

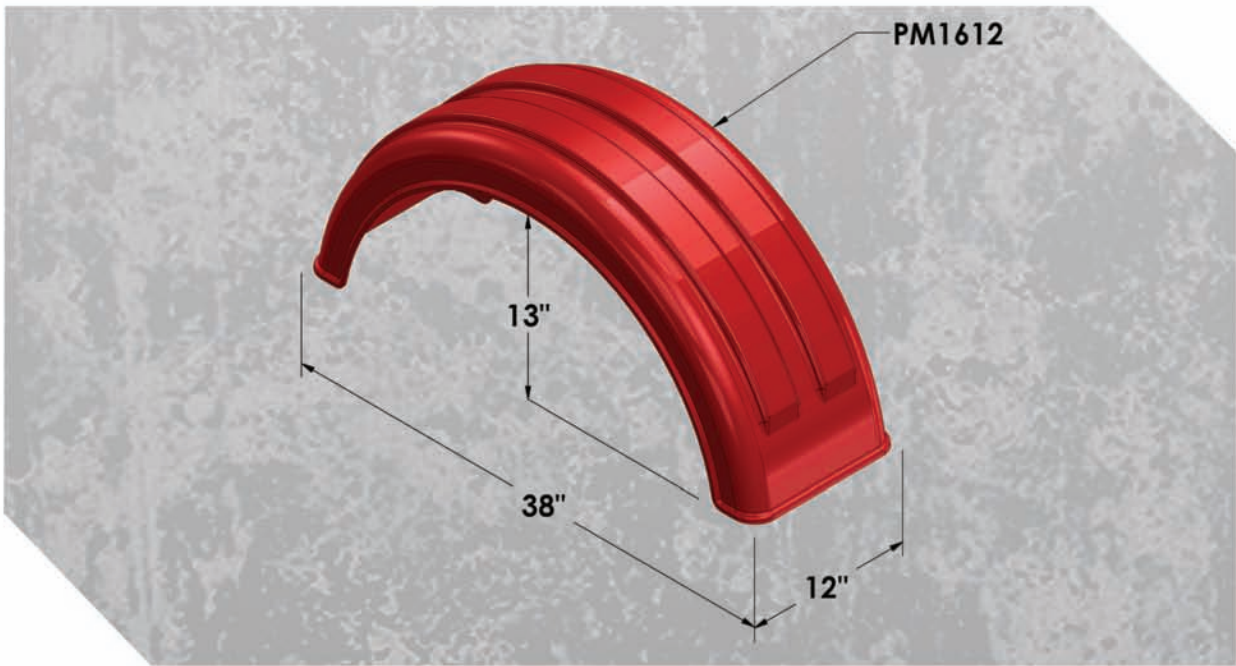

INSTALLATION **KITS**



BSHORTLIFTAX - Lift Axle Bracket Kit



Steerable Lift Axle Kit
*Part #'s are model specific call for more details -

MIN 221800



**Single Wheel Fender Set
for Wheels up to 24.5"**

18 & SINGLE

- MIN221800 is designed to fit a super single tractor or trailer 22.5" or 24.5" wheel (445).
- The set consists of 2 pieces. (2-PM2218 fender sections)
- The total weight of the MIN221800 is less than 16 pounds.
- MIN221800 works great on super singles and steer axles.
- See page 77 for complete list of fenders and additional color, material, and lightbox options.

AN AMERICAN FAMILY OWNED COMPANY FOR 30 YEARS

MINIMIZER.COM

800.248.3855

18 & SINGLE

"The sales people are very knowledgeable and helped me decide on the fenders that best suited my needs."

SINGLE WHEEL FENDERS **SPECS**

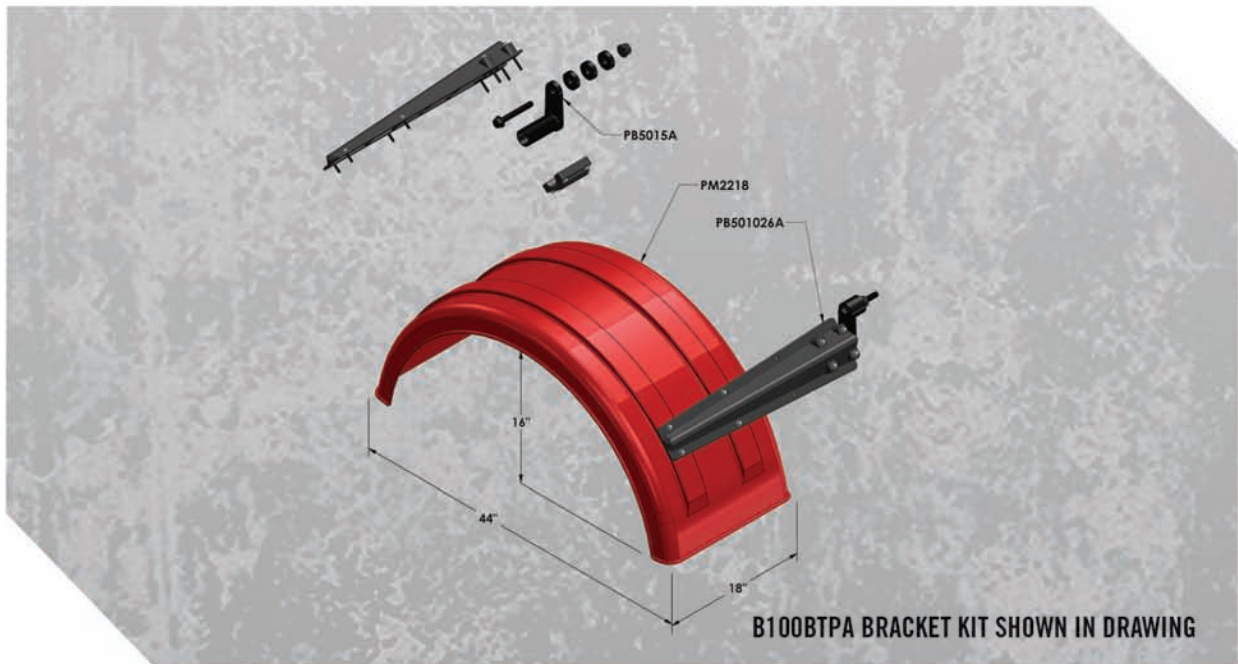

INSTALLATION **KITS**

- B100**BTPA** - Black Plastic Bolt-on Kit
- B100**BTPACF** - Carbon Fiber Plastic Bolt-on Kit
- B100**BTPACHROME** - Chrome Plastic Bolt-on Kit
- B100**BTPAPL** - Liquid Platinum Plastic Bolt-on Kit
- B100**PBA** - Plastic Paddle Bracket Bolt-on Kit
- B100**B TSA** - Stainless Bolt-on Kit
- B100**WOA** - Weld-on Kit

SEE **PAGE 79-80** FOR MORE INFORMATION ON AVAILABLE INSTALLATION KITS

MINTF900/1554



Tanker Fenders Set

TANKER FENDERS

- MINTF900/1554 is designed to fit the front of a tanker trailer.
- The set consists of 8 pieces (2 - PMTF44EC End Caps, 4 - PMTF44 Center Sections, and 2 - PM901 Rear Sections or 2 - PM1554 Rear Sections)
- The total weight of the MINTF900 fender kit is less than 49 pounds.
- See page 77 for complete list of fenders and additional color, material, and lightbox options.

AN AMERICAN FAMILY OWNED COMPANY FOR 30 YEARS

MINIMIZER.COM

800.248.3855

ANKER FENDERS

“Minimizer poly fenders have a lifetime warranty, which is more than I can say for my last 3 sets of aluminum.”

TANKER FENDERS **SPECS**

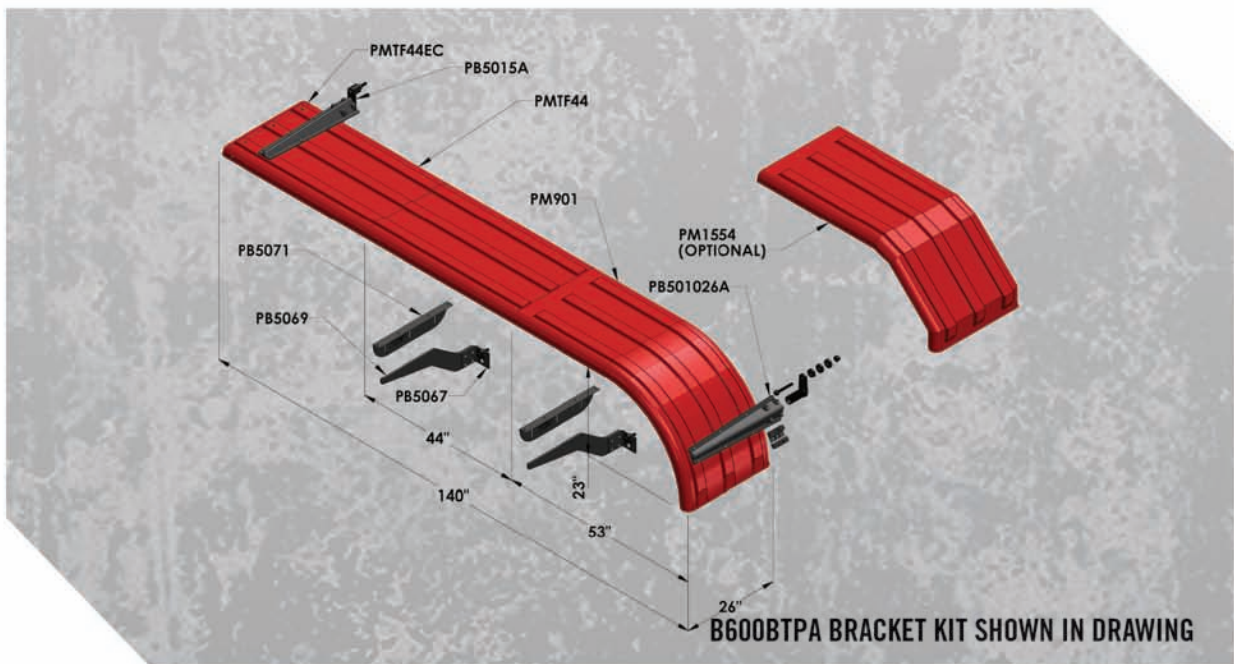

INSTALLATION **KITS**

- B600**BTPA** - Black Plastic Bolt-on Kit
- B600**BTPACF** - Carbon Fiber Plastic Bolt-on Kit
- B600**BTPACHROME** - Chrome Plastic Bolt-on Kit
- B600**BTPAPL** - Liquid Platinum Plastic Bolt-on Kit
- B600**PBA** - Plastic Paddle Bracket Bolt-on Kit
- B600**BTSA** - Stainless Bolt-on Kit
- B600**WOA** - Weld-on Kit

SEE **PAGE 79-80** FOR MORE INFORMATION ON AVAILABLE INSTALLATION KITS

MIN 1400

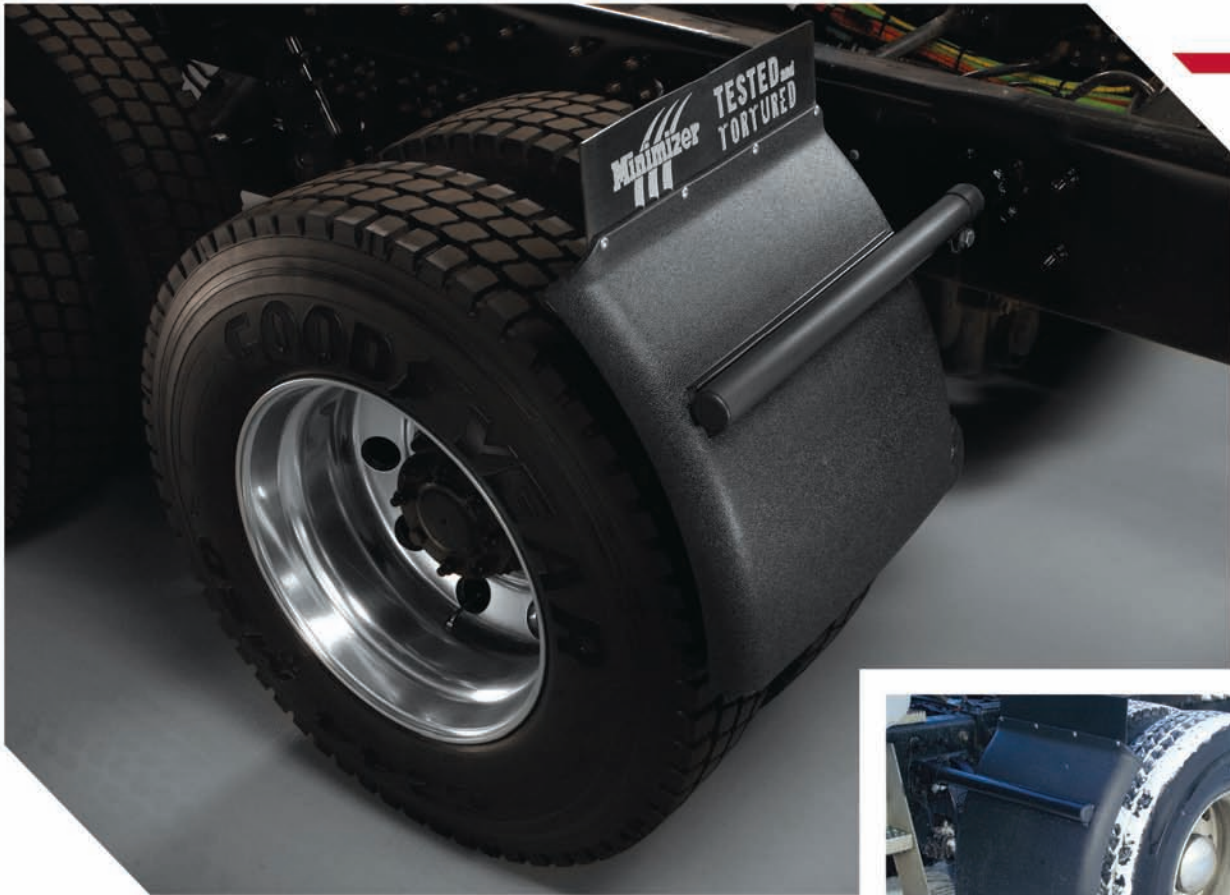

**For Dual Wheels
of Various Size**

THE QUARTER

- MIN1400 is designed to fit standard dual tractor or trailer wheels.
- This is a complete kit. Pair of fenders and all mounting hardware included.
- The total weight of the MIN1400 fender kit is less than 35 pounds.
- Optional frame mount includes flange, swivel or post mount.
- See page 77 for complete list of fenders and additional color, material, and lightbox options.

AN AMERICAN FAMILY OWNED COMPANY FOR 30 YEARS

MINIMIZER.COM

800.248.3855

THE QUARTER

"The sales people are very knowledgeable and helped me decide on the fenders that best suited my needs."

SINGLE WHEEL FENDERS **SPECS**

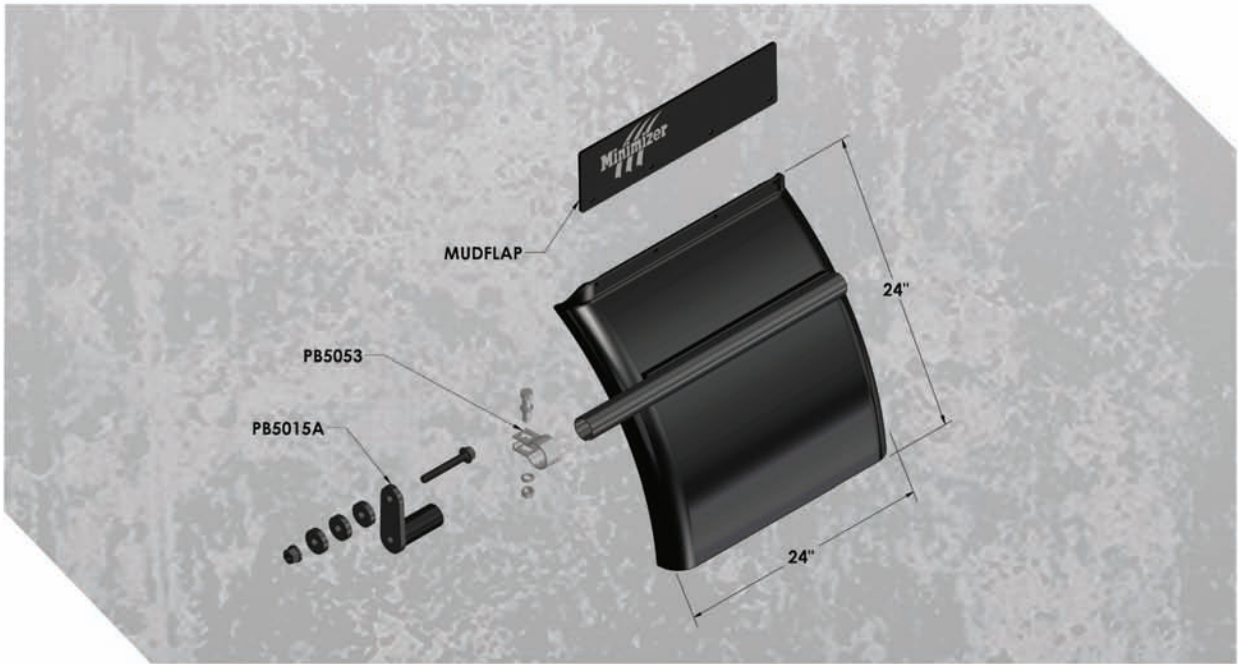

INSTALLATION **KITS**



Post Mount



Flange Mount

500 MINIMIZER WAY SE, BLOOMING PRAIRIE, MN 55917



MIN FENDER **OPTIONS**

Fender Series	Options	Black	Galvanized	Red	White	Green	Paintable	Diamond Plate Black	Diamond Plate Silver	Liquid Platinum	Carbon Fiber	Chrome Poly	Optional Light Box
MIN1600		X	X	X	X	X	X	X	X	X	X	N/A	N/A
MIN1900		X	X	X	X	X	X	X	X	X	X	N/A	X
MIN2260		X	X	X	X	X	X	X	X	X	X	X	X
MIN2480		X	X	X	X	N/A	N/A	X	X	N/A	N/A	N/A	X
MIN150		X	X	X	X	X	X	X	X	X	X	N/A	N/A
MIN200		X	X	X	X	X	X	X	X	X	X	N/A	N/A
MIN4000		X	X	X	X	X	X	X	X	X	X	X	N/A
MIN900		X	X	X	X	N/A	X	X	X	X	X	X	X
MIN135200		X	X	X	X	N/A	X	X	X	X	X	X	X
MIN135400		X	X	X	X	N/A	X	X	X	X	X	X	X
MIN1500		X	X	X	X	N/A	X	X	X	X	X	N/A	X
MIN1554		X	X	X	X	N/A	X	X	X	X	X	N/A	X
MIN300		X	X	X	X	X	X	X	X	X	X	N/A	N/A
MIN318		X	X	X	X	X	X	X	X	X	X	N/A	N/A
MINTA1554		X	X	X	X	N/A	X	X	X	X	X	N/A	X
MINTA910		X	X	X	X	N/A	X	X	X	X	X	N/A	X
MIN202-302-1021		X	X	X	X	X	N/A	X	X	N/A	N/A	N/A	N/A
MIN4050		X	X	X	X	X	X	X	X	X	X	X	N/A
MIN950		X	X	X	X	N/A	X	X	X	X	X	X	N/A
MIN1550		X	X	X	X	N/A	X	X	X	X	X	N/A	N/A
MIN161200		X	X	X	X	X	X	X	X	X	X	N/A	N/A
MIN221800		X	X	X	X	X	X	X	X	X	X	N/A	N/A
MINTF1554		X	X	X	X	N/A	X	X	X	X	X	N/A	X
MINTF900		X	X	X	X	N/A	X	X	X	X	X	N/A	X
MIN1400		X	N/A	N/A	N/A	N/A	N/A	N/A	N/A	N/A	N/A	N/A	N/A

AN AMERICAN FAMILY OWNED COMPANY FOR 30 YEARS

MINIMIZER.COM

800.248.3855

ENDER OPTIONS

"The sales people are very knowledgeable and helped me decide on the fenders that best suited my needs."



INSTALLATION **KITS**

IN

B100 SERIES:



B100BTPA - Plastic Bolt-on Kit*



B100PBA - Paddle Bracket Kit



B100BTSA - Stainless Bolt-on Kit



B100W0A - Weld-on Kit

B200 SERIES:



B200BTPA - Plastic Bolt-on Kit*



B200PBA - Paddle Bracket Kit



B200W0A - Weld-on Kit

B300 SERIES:



B300BTPA - Plastic Bolt-on Kit*



B300PBA - Paddle Bracket Kit



B300W0A - Weld-on Kit

B4578 SERIES:



B4578BTPA - Plastic Bolt-on Kit*



B4578PBA - Paddle Bracket Kit



B4578BTSA - Stainless Bolt-on Kit



B4578W0A - Weld-on Kit

AN AMERICAN FAMILY OWNED COMPANY FOR 30 YEARS

MINIMIZER.COM

800.248.3855

STALLATION KITS

B4850 SERIES:



B4850BTPA - Plastic Bolt-on Kit*



B4850PBA - Paddle Bracket Kit



B4850BTSA - Stainless Bolt-on Kit



B4850W0A - Weld-on Kit

B600 SERIES:



B600BTPA - Plastic Bolt-on Kit*

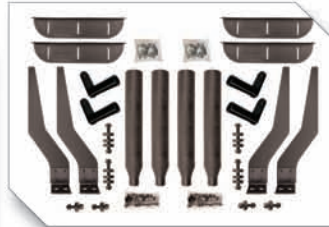

B600PBA - Paddle Bracket Kit

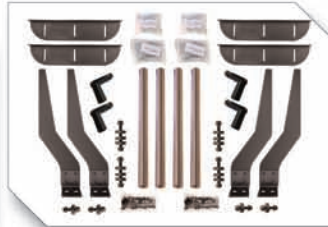

B600BTSA - Stainless Bolt-on Kit



B600W0A - Weld-on Kit

B9900 SERIES:



B9900BTPA - Plastic Bolt-on Kit*



B9900PBA - Paddle Bracket Kit



B9900W0A - Weld-on Kit



B9900W0A - Weld-on Kit

*Plastic Bolt-on Kits are also available with Chrome, Carbon Fiber, and Liquid Platinum Bracket Arms.

All kits come with the applicable mounting hardware for proper installation:

- Bracket Arms
- Plastic Center Bracket Assembly (Plastic Arm mounted to Steel Angle)
- Plastic Angle/Height Support
- Mounting Flanges, Mounting Bolts, and Spacers
- All Bolts, Washers, and Nuts

500 MINIMIZER WAY SE, BLOOMING PRAIRIE, MN 55917



when

“**TO HELL
AND BACK**”

is the job description

MINIMIZER POLY PRODUCTS

• **TESTED AND TORTURED™** •

DAILY BY TRUCKERS FOR TRUCKERS

A close-up photograph of a red tool box. The box has a textured surface and a black handle. A logo is centered on the handle, featuring the word "Minimizer" in a bold, white, sans-serif font. The logo is flanked by stylized white curved lines that resemble a saw blade or a similar tool. Below the main text, the words "TOOL BOXES" are written in a large, bold, white, sans-serif font.

Minimizer

TOOL BOXES

MINIMIZER™ TOOL BOXES



MINIMIZER™ TOOL BOXES ARE VIRTUALLY INDESTRUCTIBLE! PLUS, THEY DON'T LEAK, SWEAT OR RUST AND THEY MAKE A GREAT TOOL SAVER.

Truck & Trailer tool boxes - like our fenders – are tough enough for the most demanding work sites and weather. Made of solid molded plastic material our tool box will never rust, crack or need paint. Don't let their 27 lb. frame fool you – these boxes are no lightweights. They're tougher than metal boxes weighing 10 times more: and the ¾" gutter and Seal Tight™ weather stripping means poly-tool boxes are uncannily weather-proof.

Our tool boxes mount easily to most trucks in minutes. Heavy-duty hardware keeps the plastic truck tool box as secure as a safe.



The "Vector T Latch" is number one in durability. It comes with a (standard) built in cylinder lock and two keys.



"Super Springs" provide for a self-lifting door on the chest style boxes.



With a ¾" gutter and "Seal Tight" weather stripping – weather-tight.

AN AMERICAN FAMILY OWNED COMPANY FOR 30 YEARS

MINIMIZER.COM

800.248.3855

TOOL BOXES



Poly Chest Box:

Two standard sizes:

T36CHMIN - 20" x 19" x 36" 30 lbs.

T24CHMIN - 20" x 19" x 24" 27 lbs.



Poly Underbody Box:

Two standard sizes:

T36UBMIN - 20" x 19" x 36" 30 lbs.

T24UBMIN - 20" x 19" x 24" 27 lbs.

Underbody Bracket Kits:

PTBKBYR - Buyers (250lbs. max)

FIVE STANDARD COLORS



Red, Yellow, White, Grey, and Black. Custom colors available on fleet orders

500 MINIMIZER WAY SE, BLOOMING PRAIRIE, MN 55917





LEAVE YOUR MARK ON THE WORLD NOT YOUR FLOOR.

MINIMIZER POLY PRODUCTS

• **TESTED AND TORTURED™** •

DAILY BY TRUCKERS FOR TRUCKERS



Minimizer

ACCESSORIES

FLOOR MATS



MINIMIZER™ FLOOR MATS HAVE ARRIVED

Whether it is the mud and snow off your boots, your morning coffee or your Big Gulp, the latest innovation from Minimizer™ is designed to protect the floor of your truck for years to come.

The engineers at Minimizer™ use cutting edge technology to scan the interior measurements and angles of each specific make and model semi cab to ensure an exact fit. A retention hook mounted to the base of the stick shift is designed to keep your floor mat in place.

CONTACT MINIMIZER™ TO LEARN MORE ABOUT CURRENT AVAILABLE STYLES AND FUTURE RELEASES!

AN AMERICAN FAMILY OWNED COMPANY FOR 30 YEARS

MINIMIZER.COM

800.248.3855

ACCESSORIES



Our tray system was designed to be removed easily for quick cleaning. In a matter of seconds you can have your Minimizer™ Floor Mats looking new and reinstalled so you can get your truck back on the road.

The textured surface will ensure your boots always get a solid grip. They will not break or crack under extreme conditions and are backed by a Lifetime Manufacturers Warranty.

Made out of a proprietary thermoplastic, Minimizer™ Floor Mats are designed to hold up to the daily abuse of the heavy duty trucking industry.



TIRE MASK MINIMIZER

PROFESSIONAL QUALITY PAINT
**IN A FRACTION
OF THE TIME!**

MINIMIZER POLY PRODUCTS

• **TESTED AND TORTURED™** •

DAILY BY TRUCKERS FOR TRUCKERS



AN AMERICAN FAMILY OWNED COMPANY FOR 30 YEARS

MINIMIZER.COM

800.248.3855

ACCESSORIES



MINIMIZER™ TIRE MASKS HAVE ARRIVED!

Minimizing maintenance costs are essential for any fleet operator and no task can be more tedious and more time consuming than painting rims. The new patented Minimzer™ Tire Mask system can significantly reduce fleet operating costs by reducing masking and cleanup time by up to 90%. Now, even the oldest rims can look brand new.

The Tire Mask kit is designed to protect tires from primer and paint over-spray when painting your rims but eliminates the need to fully tape and mask your entire wheel. Its patented technology is specifically designed for different sizes of tires. The kit comes with a Tire Mask, which is available in 5 different sizes and once taped to the tire protects your exact size of tire from paint and primer over spray. The Minimzer™ Tire Mask kit also includes a patented Hubb Capp protector and a Rim Shield to ensure a precise painted finish without any of the cleanup and in a fraction of the time. All the pieces of the Minimzer™ Tire Mask kit can be reused for multiple applications.

TIRE MASKS ARE AVAILABLE FOR 16", 17.5", 19.5", 22.5", AND 24.5" WHEELS

500 MINIMIZER WAY SE, BLOOMING PRAIRIE, MN 55917



LED LIGHTS MINIMIZER



LED 4" ROUND LED CONSISTS OF STOP, TURN & TAIL LIGHTS

Our 12 diode LED lights are brighter and therefore safer than any incandescent light on the market. No more "burned out" tail lights... if one of the 12 diodes should ever fail, 11 are still on the job. This standard 4" model is made to perfectly fit the openings of our fender light box option.

Included with your LED light purchase is our black poly mounting grommet. It fits perfectly into our fender openings and the seal around your light keeps weather out.

Kit also includes 6 chrome bezel trim pieces. (As shown in picture.)

- ACCLED1200

AN AMERICAN FAMILY OWNED COMPANY FOR 30 YEARS

MINIMIZER.COM

800.248.3855

ACCESSORIES

LIFT AXLES **BRACKETS**



- Designed specifically for 5" round lift axles.
- Easy bolt-on design for a quick installation.
- Available for single wheel applications.
- Fenders are also available.
- Fenders are molded for a specific tire size.
- Please reference Part# BSHORTLIFTAX

The Bracket Kit clamps on to a 5" round axle allowing the fender to raise and lower with the axle.

MINIMIZER STEERABLE AXLES **BRACKETS**



- Designed specifically for steerable axles.
- Easy bolt-on design for a quick installation.
- Over 20 different kits are available depending on the style and brand of your axle.
- Fenders are also available.
- Call for part numbers and availability. Kits are made specific for axle and brake cam assemblies. Steerable kits are made to bolt on using existing holes on the brake assembly.

AN AMERICAN FAMILY OWNED COMPANY FOR 30 YEARS

MINIMIZER.COM

800.248.3855

ACCESSORIES

SLICK **DISK**



Slick. Just like the rest of our products.

- Protects the 5th wheel against friction and wear that can be caused by normal towing.
- Nearly eliminates the need for greasing the face of the 5th wheel plate.
- Installs in minutes
- Disk comes with clip.
- Please reference Part# ACCSLICK32ASSY

MUD **FLAPS** MINIMIZER



CUSTOM MUD **FLAPS**

- Put your logo, telephone number or web site on display while protecting your rig and other drivers. (Most trucks average 10 million sightings per year per truck.)
- Poly or rubber materials are strong and stay stiffer on your trailers.
- These truck mud flaps will last for years without fading or tearing.
- We're fast. We're extremely competitively priced – often our custom printed flaps are less expensive than “off the rack” flaps.

AN AMERICAN FAMILY OWNED COMPANY FOR 30 YEARS

MINIMIZER.COM

800.248.3855

ACCESSORIES

CUSTOM MUD **FLAPS**

We have complete graphic services available for your design, typesetting or proofing needs. Contact us for more information on our custom mud flaps.

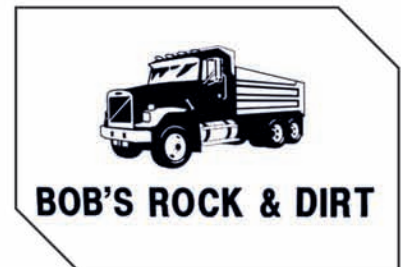

TESTED POSITIVE FOR PERFORMANCE ENHANCERS

MINIMIZER POLY PRODUCTS

• **TESTED AND TORTURED™** •

DAILY BY TRUCKERS FOR TRUCKERS



OTHER INFORMATION

SERVICE PARTS



FAST SHIPPING ON REPLACEMENT PARTS

Hey, Minimizer™ products are tough... made to take a beating. But on the rare occasion that you need a replacement part -- a bracket, a bolt, an individual fender... whatever -- it's our job to make sure you get it fast. We keep a complete inventory of every part we sell. So if you happen to need a replacement part for anything we sell, call direct and we'll get it shipped from our dock as fast as we can.

AN AMERICAN FAMILY OWNED COMPANY FOR 30 YEARS

MINIMIZER.COM

800.248.3855

SERVICE PARTS

THE RIGHT PART, RIGHT NOW



FAST **SHIPPING** ON REPLACEMENT PARTS

500 MINIMIZER WAY SE, BLOOMING PRAIRIE, MN 55917



OUR FAMILY'S **WARRANTY**

Before the legal guys have their say, here's the deal:

We're all only human and we know that sometimes, "stuff" happens. With our extensive background in plastic materials and the trucking industry, we also fully understand the physical properties of the materials we use and we know that our plastic doesn't just "break" or "crack" under normal use, unless the unforeseeable happens. If so – we have probably done it ourselves, or have tested our material to the utmost extremes and have seen it before. Be sure to check out our videos at www.minimizer.com or www.youtube.com or ask a Minimizer™ sales representative for one to see how brutally we test our products.

We've engineered our fenders & brackets to last longer than the life of your truck. We're a family company, we so we truly do care about the products we produce on a daily basis.

We have an inherent respect for you, our customer, who makes their living using the vehicles and equipment our products serve to protect. So don't tell us you were "driving along" when your bracket broke or it bent back and your wheel is now rubbing the fender. We are drivers and were founded by a driver, so we've been around the block a few times. If you dumped your truck into a monster pothole, dropped a trailer, got hit by a reckless vehicle operator or backed over your flap and pulled the fenders off we sympathize with you and will try to help you out, as we've done or seen all those things. We want you to keep running our products on all your trucks, so in the unlucky event of stuff happening, please refer to our Stuff Happens (SH) policy below.

SH POLICY

In the event customers have a misfortune with our product we will work with them to either offer to replace the part in question or sell replacement parts at a significant discount to our customers who forget that our products are not at all times "invincible". We extend this to original owners only. If you bought our product at an authorized Minimizer™ dealer, please see them for details. We will require a digital photo of the damage or the original part back. We promise to make it right for you. We do not want an "accident" to leave a bad taste in your mouth regarding Minimizer™ Products. Always remember we have been in the trucking industry for 30 years and have seen it all. Nothing is unexpected with us.

Tell us your story as we love to hear what our fenders go through on a day to day basis. If it's a good story we will even brag about it on our website.

AN AMERICAN FAMILY OWNED COMPANY FOR 30 YEARS

MINIMIZER.COM

800.248.3855

LY'S WARRANTY

MEET THE **FAMILY - FOUR GENERATIONS**

"Our pride is your assurance that you will get only our very best with every order"

- The Kruckeberg Family



A family operation is a special operation. We know quality products and commitment to our customers is the foundation for our future. We know our reputation as a family run company ships right along with every product we produce.

When your name and your children's, grandchildren's and great grand children's future are shipping with your products, you get it right every time. We are proud of the innovations of our poly fenders, floor mats, tool boxes, mud flaps, and Slick Disk.

We are proud of the people who make them. We are proud to be a family run business in the USA.

500 MINIMIZER WAY SE, BLOOMING PRAIRIE, MN 55917



LAWYER'S WARRANTY

WARRANTY AND LIMITATION OF REMEDIES

1. GENERAL CONDITIONS.

Spray Control Systems, Inc. ("SCSI") provides the following Warranty and Limitation of Remedies for the products identified below.

The specific SCSI products identified below will be free from defect in materials and workmanship for the specific periods stated for each product.

SCSI MAKES NO OTHER WARRANTY, EXPRESS OR IMPLIED, EXCEPT AS ARE SPECIFICALLY SET FORTH IN THIS DOCUMENT. SCSI MAKES NO IMPLIED WARRANTIES, INCLUDING ANY IMPLIED WARRANTY OF MERCHANTABILITY OR FITNESS FOR A PARTICULAR PURPOSE. Additionally, this warranty is in lieu of all other obligations or liabilities on the parts supplied by SCSI.

IN NO EVENT WILL SCSI BE LIABLE FOR AN AMOUNT IN EXCESS OF THE PURCHASE PRICE OF ITS PRODUCTS FOR ANY LOSS OR DAMAGE, WHETHER DIRECT OR IN-DIRECT, INCIDENTAL, CONSEQUENTIAL, OR OTHERWISE, INCLUDING, BUT NOT LIMITED TO, LOST PROFITS OR PUNITIVE DAMAGES ARISING OUT OF THE ALLEGED FAILURE OF SCSI'S PRODUCT.

SCSI will not be held monetarily or legally responsible, in whole or in part, for final product configurations which exceed structural limits, weight or length restrictions, which are not within accepted automotive manufacturing practices.

SCSI will not be responsible for damages or breakage caused by alterations or installation of the product.

All returned product for warranty claims are analyzed and the condition of the product is thoroughly documented. If any product is returned due to a manufacturing defect or product failure, a corrective action is assigned to the particular part, and a parts specialist will contact you as to how the warranty will be handled and inform you of all actions that will be taken. SCSI reserves the right, at its sole option,

to satisfy its warranty obligations for products determined by SCSI to qualify by returning a repaired product, replacing the product, or refunding the purchase price.

The set warranties are not transferable beyond the original owner. Should any problems develop with the Minimizer™ fender, mounting hardware, mud flaps, floor mats or tool boxes contact SCSI at the toll free service number- 800-248-3855. Keep a copy of the original invoice to claim & validate your warranty. SCSI neither assumes nor authorizes any person supposing to act on its behalf, to change, nor to assume for it, any warranty or liability concerning its products.

Due to the use of the highest quality products, best in technology, and the continued use of good workmanship, Spray Control Systems, Inc. is able to offer one of the best warranties in the truck & trailer industry. We continually push the boundaries and will stand 100% behind all products shipped through our doors under the following guidelines listed below.

Spray Control Systems, Inc. warranty is broken down into specific product type, please read and inform yourself of each specific products conditional warranty as they may apply. Any questions regarding wording or warranty please contact SCSI at 800-248-3855.

2. SPECIFIC PRODUCTS.

A. Standard Fender Products.

A.1 SCSI warrants that, as long as the products remain on the original vehicle, and are owned by the original purchaser of the SCSI product, for the useful life of the Minimizer™ Fender (i) all polyethylene components will be free from defects in material and workmanship, including free from rust and corrosion; and (ii) the standard four set primary colors described in the catalogue, and on the web site, will be free from all color shifts.

A.2 SCSI warrants that paint film used on standard

AN AMERICAN FAMILY OWNED COMPANY FOR 30 YEARS

MINIMIZER.COM

800.248.3855

ER'S WARRANTY

fender products will be free from defects in material and workmanship, subject to the exclusions below, for three (3) years after date of purchase.

A.2.1 Warranty is void if the paint itself is defective.

A.2.2 Any specialty products or colors are not warranted for color shifts.

A.2.3 Warranty for standard four-set primary colors includes peeling, chipping and fading. In no event will the warranty apply to films altered by outside forces. Contact with trailers, other debris or simple accidents void the warranty, and will be the sole responsibility of owner to repair at their cost.

A.3 SCSI warrants that, as long as the products remain on the original vehicle, and are owned by the original purchaser of the SCSI product, Minimizer™ Fender products will be free from stress cracks, dents and tears under normal operating conditions for the useful life of the product. If the condition is caused by non-normal operating conditions such as a motor vehicle accident, the warranty is inapplicable.

A.4 Minimizer™ molded tail light sections, provided with some fender products, are water resistant, but are not WATERPROOF. Attachment of the mud flaps, regardless of whether they are DOT regulated, directly to the bottom of the light box fender will void any and all applicable warranty. SCSI will not be held responsible for damages caused by mud flaps or mud flap installation.

A.5 Any Minimizer™ Fender product not mounted with Minimizer™ mounting hardware will void all warranties.

B. Specialty Fender Products.

Specialty Fender Products have the same warranty and limitations as Standard Fender Products, except as noted

in Section A.2.2 the warranty against color shifts does not apply to Specialty Fender Products.

C. Mud Flaps.

All Minimizer™ brand mud flaps are warranted for one (1) year from date of purchase against breakage, curling and separation under normal operating conditions within the recommended service temperature of -40F to +150F.

D. Tool Box.

D.1 SCSI warrants that all of the polyethylene components will be free from defects in materials and workmanship for a period of one (1) year from the date of purchase.

D.2 SCSI warrants the polyethylene will be free from rust and corrosion for the useful service of its life of the Minimizer™ Tool Box.

D.3 SCSI warrants all hardware and mechanical components to be free from defects in materials and workmanship for a period of one (1) year from date of purchase.

E. Mounting Hardware.

SCSI warrants all mounting hardware to be free from defects in materials and workmanship for the period of one (1) year from purchase.

F. Floor Mats

Minimizer Floor Mats are backed by a Lifetime Manufacturer's Warranty and are guaranteed against flaws due to faulty materials and/or unintended production variations. This warranty extends only to the original purchaser and excludes damage caused by abnormal use or conditions, including but not limited to extreme abrasive conditions and/or excessive exposure to chemicals such as bleach, gasoline and other fuels.

MAINTENANCE /

MAINTENANCE



The Minimizer™ fender itself should never need maintenance other than the occasional wash using any all-purpose cleaner. Paint is not necessary because the polyethylene material used to make the Minimizer™ fender is corrosion resistant.

Make sure that all the bolts attaching the fender to the mounting hardware are snug and not overly tight. Occasionally check the bolts holding the mounting hardware to the frame to assure they are securely tightened.

If you bend or break any of the mounting hardware replace them immediately. This will relieve any stress on the fender. If you have any questions about your Minimizer™ fenders please do not hesitate to call our customer service department at 800-248-3855.

Again, thank you for choosing Minimizer™ Poly Fenders.

AN AMERICAN FAMILY OWNED COMPANY FOR 30 YEARS

MINIMIZER.COM

800.248.3855

RETURN POLICY

Spray Control Systems, Inc. wants you to be happy with any purchase that you make from us; therefore we offer only high quality merchandise that we feel is superior in materials and craftsmanship. If you are unhappy with your purchase feel free to contact us and we will be happy to make it right.

We'd like to help you resolve a purchase problem as quickly and easily as possible provided you meet the terms and conditions listed below. Please note that NOT ALL items are covered by our RMA Policy. You may return your purchased products within 15 days of the invoice date. After 15 days, no merchandise can be returned unless defective or within the terms of the manufactures warranty. Anything returned without an RMA number on the outside of the package will be refused and sent back to the company.

MERCHANDISE RETURN POLICY

1. All merchandise returned will be subject to a 20% restocking charge. All sales are subject to approval before return. Our knowledge of your intent to return the merchandise will insure that you receive proper credit.

2. Please provide the following information when calling or e-mailing for an RMA number: Customer Name, Contact Name, Zip Code (Billing), Sales Order Number, SCSi Part# and Quantity, along with the nature of the problem.

3. New merchandise will be accepted for credit only with prior approval by an SCSi Product Specialist. Your Product Specialist will issue a RETURNED MATERIAL AUTHORIZATION (RMA) number which must appear on all returned cartons and corresponding packing list's. Merchandise must be received within 30 days of issuance of the RMA number otherwise, credit will not be issued. No merchandise can be returned after 15 days unless defective or within the terms of the manufactures warranty.

Please Note: No returns will be accepted if the manufacturer's RMA# sheet is missing or is not visible on any and all packages being returned.

4. All purchased merchandise must be returned in "BRAND NEW" condition, if materials are returned in a "Less Than Brand New" condition You will be notified by an SCSi representative. A refurbishing fee may be required to restore the merchandise to a marketable condition. The fee for refurbishing will be presented to you to accept or reject, at which time the merchandise will either be reworked or returned to you. This fee is in addition to any restocking or handling fee of at least 10% which may be levied. Credit for returned merchandise will be issued at the original purchase price minus any fees listed above. Only merchandise purchased within the past fifteen (15) days may be returned. Special order merchandise can not be returned at any time.

5. If the returned packages are missing any of the manufacturers supplied accessories or there is obvious damage or visible wear and tear to the merchandise, Spray Control Systems, Inc. reserves the right to refuse the return.

6. If you are trying to return/exchange an item that you've tried to install and the item has become damaged so that it is no longer in "BRAND NEW" condition, we will not be able to accept a return/exchange on that item. We can only allow returns/exchanges for new and unused parts that have not been installed and/or damaged.

7. All products are sold with their respective manufacturer's warranties. Please note that warranty periods and services vary depending on the product.

8. The purchaser will be responsible for return shipping costs. When returning products, we strongly recommend the use of a carrier that can track packages. Spray Control Systems, Inc. does not reimburse any customers return shipping cost. Claims for delay, loss, or damage should be made against the freight carrier.

9. Spray Control Systems, Inc. will not accept any returns shipped freight COD or UPS COD. If you ship items to us, please insure the items to their full value and request proof of delivery. Items must be in a reasonable return package, to insure they are returned in a "BRAND NEW" condition. If not, damage may occur in the shipping process, which SCSi will not be held responsible, and may cause the product to be returned in a "NOT LIKE BRAND NEW" condition.

10. Returned goods privileges will apply only to customers currently purchasing Minimizer™ Products and whose accounts are in current condition. No cash settlement will be made, if you are inquiring about RMA # for merchandise that was purchased through one of Spray Control Systems, Inc. qualified dealers, and not directly from SCSi, please contact your point of purchase retailer, and notify them. They will be responsible for the return of merchandise.

11. The customer shall not deduct amounts for returned merchandise from payments to Spray Control Systems, Inc. When approved returned merchandise has been received, inspected, and processed, Spray Control Systems, Inc. will promptly issue credit to the customer account or Customers Credit Card. No deduction shall be made until the credit memo has been issued.

12. Customers returning merchandise which is not approved for credit or replacement will be notified in writing by a Spray Control Systems, Inc. Representative. Failure by the customer to respond within ten (10) days to such notice will be just cause for Spray Control Systems, Inc. to scrap or return the merchandise, freight collect, back to the customer.

13. Customers needing additional assistance regarding the Merchandise Return Policy should contact Spray Control Systems, Inc. and ask to speak to a representative.

REQUESTING AN RMA#

You may choose to use our RMA form for requesting a product return online through our web site's RMA form:

Request RMA

Anything returned without an RMA number on the outside of the package will be refused and sent back to the company.

After receiving your RMA Number, place your RMA# sheet in a clear visible spot and write your RMA number legibly on the return label and the outside of the box and return the entire package to:

Spray Control Systems, Inc.

500 MINIMIZER WAY SE, BLOOMING PRAIRIE, MN 55917



MINIMIZER ON THE **WEB**

WE NOW OFFER A **FREE CANVAS PRINT** OF YOUR TRUCK WITH MINIMIZER™ FENDERS!



If you would like a FREE canvas print of your truck sporting Minimizer™ fenders please provide a high res JPEG image and your address via email info@minimizer.com or use the submission form at <http://www.minimizer.com/submityours.html>.

Note: Size of print will vary with size and orientation of image provided. (12x12, 16x18, or 18x20). Limit one per household or business. By submitting your photo you agree to allow Minimizer™ or its partners the usage of your submission for marketing purposes.

TALK TO US @ WWW.MINIMIZER.COM

The Minimizer™ website is packed full of useful information.

- Browse all of our models of fenders as well as their available finishing options.
- Find mounting and installation instructions
- Read the latest press releases to learn more about the exciting new products Minimizer™ is coming out with!
- Submit your photos, stories, product feedback or product ideas.

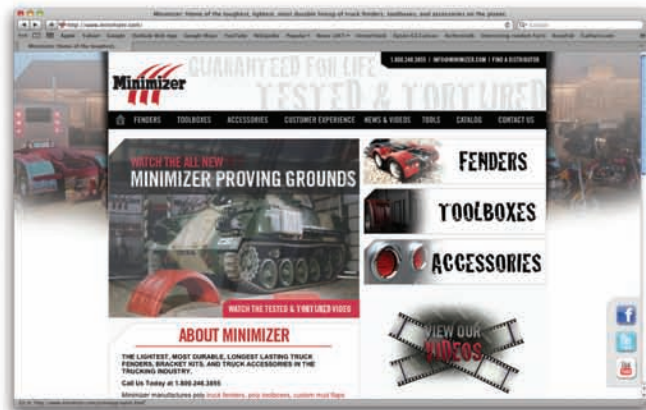

AN AMERICAN FAMILY OWNED COMPANY FOR 30 YEARS

MINIMIZER.COM

800.248.3855

R ON THE WEB

WE'RE SOCIAL @ MINIMIZER™

Minimizer™ realizes the importance of social networking. Follow us on Facebook and Twitter! You'll get the latest product news, company updates, and distributor news. You'll have access to the videos and you can follow us at trade shows and keep track of our new Innovation & Training Trailer!



BE SURE TO CHECKOUT OUR NEW **MOBILE SITE!**



The new Minimizer™ mobile site is formatted specifically to fit the screen of your smart phones and tablets allowing you access to all of the same useful information available on our standard website...wherever you have coverage!

www.minimizer.com

500 MINIMIZER WAY SE, BLOOMING PRAIRIE, MN 55917



CUSTOMER PHOTOS



AN AMERICAN FAMILY OWNED COMPANY FOR 30 YEARS

MINIMIZER.COM

800.248.3855

TOMER PHOTOS



500 MINIMIZER WAY SE, BLOOMING PRAIRIE, MN 55917





MINIMIZER POLY PRODUCTS

• **TESTED AND TORTURED™** •

DAILY BY TRUCKERS FOR TRUCKERS

Manufactured by Spray Control Systems, Inc. (SCSI)
500 Minimizer Way Blooming Prairie, MN 55917
800.248.3855 • Fax: 888.583.7540
www.minimizer.com